

# GV-IP LPR Camera

## *User's Manual*



- GV-LPC2210
- GV-LPC2211
- GV-LPC2011
- GV-LPR1200
- GV-LPC1200
- GV-LPC1100
- GV-IP LPR Cam 5R

Before attempting to connect or operate this product, please read these instructions carefully and save this manual for future use.



© 2016 GeoVision, Inc. All rights reserved.

Under the copyright laws, this manual may not be copied, in whole or in part, without the written consent of GeoVision.

Every effort has been made to ensure that the information in this manual is accurate. GeoVision, Inc. makes no expressed or implied warranty of any kind and assumes no responsibility for errors or omissions. No liability is assumed for incidental or consequential damages arising from the use of the information or products contained herein. Features and specifications are subject to change without notice.

**Note:** No memory card slot or local storage function for Argentina.

GeoVision, Inc.  
9F, No. 246, Sec. 1, Neihu Rd.,  
Neihu District, Taipei, Taiwan  
Tel: +886-2-8797-8377  
Fax: +886-2-8797-8335  
<http://www.geovision.com.tw>

Trademarks used in this manual: *GeoVision*, the *GeoVision* logo and GV series products are trademarks of GeoVision, Inc. *Windows* and *Windows XP* are registered trademarks of Microsoft Corporation.

June 2016

# Preface

Welcome to the *GV-IP LPR Camera User's Manual*.

The GV-IP LPR Camera has a series of models designed to meet different needs. This manual is designed for the following models and firmware versions:

Models	Firmware Version
GV-IP LPR Camera 5R	1.01
GV-LPC1100	1.01
GV-LPC1200	1.10
GV-LPR1200	1.10
GV-LPC2210	1.02
GV-LPC2211	1.0
GV-LPC2011	1.0

---

**Note:** GV-LPC1100 is also referred to as GV-IP LPR Camera 10R.

---

---

**IMPORTANT:** When using GV-LPC1200 / GV-LPR1200 for the first time, you need to remove the plastic insulation film under the battery and change the silica gel bag. For details, see *1.3.6 Replacing the Silica Gel Bag* and *1.3.7 Fitting the Battery*.

---

# Contents

<b>Naming Definition .....</b>	<b>vii</b>
<b>Options .....</b>	<b>viii</b>
<b>Note for Connecting to GV-System / GV-VMS .....</b>	<b>ix</b>
<b>Note for Installing Camera Outdoor .....</b>	<b>x</b>
<b>Note for Silica Gel Bags .....</b>	<b>x</b>
<b>Chapter 1 Introduction.....</b>	<b>2</b>
1.1 GV-IP LPR Camera 5R .....	2
1.1.1 Features .....	3
1.1.2 System Requirements.....	4
1.1.3 Packing List.....	5
1.1.4 Device Installation.....	6
1.1.5 Connecting the Camera .....	7
1.1.6 Adjusting the Angles .....	8
1.1.7 Replacing the Silica Gel Bag .....	11
1.1.8 Installing the Sun-Shield Cover.....	12
1.2 GV-LPC1100 .....	13
1.2.1 Features .....	14
1.2.2 System Requirements.....	15
1.2.3 Packing List.....	16
1.2.4 Device Installation.....	17
1.2.5 Connecting the Camera .....	19
1.2.6 Replacing the Silica Gel Bag .....	23
1.3 GV-LPC1200 / LPR1200 .....	24
1.3.1 Features .....	25
1.3.2 System Requirements.....	26
1.3.3 Packing List.....	27
1.3.4 Installing the Camera .....	28
1.3.5 Connecting the Camera .....	30
1.3.7 Fitting the Battery.....	34
1.3.8 Installing a Mini USB Cable.....	35
1.4 GV-LPC2210 .....	38
1.4.1 Features .....	39
1.4.2 System Requirements.....	40
1.4.3 Packing List.....	41
1.4.4 Device Installation.....	42



1.4.5	Connecting the Camera .....	44
1.4.6	Replacing the Silica Gel Bag .....	47
1.5	GV-LPC2211/2011 .....	48
1.5.1	Features .....	49
1.5.2	System Requirements .....	51
1.5.3	Packing List .....	52
1.5.4	Device Installation .....	53
1.5.5	Connecting the Camera .....	57
1.5.6	Replacing the Silica Gel Bag .....	58
<b>Chapter 2</b>	<b>Getting Started .....</b>	<b>59</b>
2.1	Looking Up the IP Address .....	59
2.2	Changing the IP Address .....	61
2.2	Configuring the Basics .....	62
<b>Chapter 3</b>	<b>Accessing the Camera .....</b>	<b>63</b>
3.1	Accessing Your Surveillance Images .....	63
3.2	The Live View Window .....	65
3.3	The Control Panel of the Live View Window .....	67
3.4	Snapshot of a Live Video .....	71
3.5	Video Recording .....	71
3.6	Picture-in-Picture and Picture-and-Picture View .....	72
3.7	Alarm Notification .....	74
3.8	Video and Audio Configuration .....	75
3.9	Remote Configuration .....	76
3.10	Camera Name Display .....	76
3.11	Image Enhancement .....	76
3.12	Digital PTZ .....	77
3.13	I/O Control .....	78
3.14	Visual Automation .....	79
<b>Chapter 4</b>	<b>Administrator Mode .....</b>	<b>80</b>
4.1	Video & Motion .....	82
4.1.1	Video Settings .....	83
4.1.2	Motion Detection / Detection Mode .....	90
4.1.3	Privacy Mask .....	96
4.1.4	Text Overlay .....	97
4.1.5	Tampering Alarm .....	98

4.1.6	Visual Automation .....	100
4.1.7	Recognition Engine Settings .....	101
4.2	I/O Control .....	105
4.2.1	Input Settings .....	105
4.2.2	Output Settings .....	106
4.2.3	RS485 .....	108
4.3	Events & Alerts .....	109
4.3.1	E-mail .....	110
4.3.2	FTP .....	112
4.3.3	Center V2 .....	114
4.3.4	VSM (Vital Sign Monitor) .....	116
4.3.5	GV-Video Gateway / GV-Recording Server .....	118
4.3.6	RTSP .....	120
4.3.7	ONVIF .....	121
4.3.8	POS .....	122
4.3.9	Inquire Recognized Database .....	124
4.3.10	Registry Database .....	125
4.4	Monitoring .....	128
4.4.1	Monitoring Settings .....	128
4.5	Schedule .....	130
4.5.1	I/O Monitoring Settings .....	130
4.5.2	Recognizing Schedule Settings .....	131
4.5.3	WDR Settings .....	132
4.6	Network .....	133
4.6.1	LAN Configuration .....	133
4.6.2	Advanced TCP/IP .....	135
4.6.3	UMTS .....	139
4.6.4	IP Filtering .....	141
4.6.5	SNMP Settings .....	142
4.7	Management .....	144
4.7.1	Date and Time Settings .....	144
4.7.2	Storage Settings .....	146
4.7.3	User Account .....	148
4.7.4	Log Information .....	149
4.7.5	Tools .....	150
4.7.6	Language .....	152

<b>Chapter 5</b>	<b>Advanced Applications</b>	<b>153</b>
5.1	Upgrading System Firmware	153
5.1.1	Using the Web Interface	154
5.1.2	Using the GV-IP Device Utility	155
5.2	Backing Up and Restoring Settings	158
5.3	Restoring to Factory Default Settings	160
5.3.1	Using the Web Interface	160
5.3.2	Directly on the Camera	160
5.4	Verifying Watermark	162
5.4.1	Accessing AVI Files	162
5.4.2	Running Watermark Proof	162
5.4.3	The Watermark Proof Window	163
<b>Chapter 6</b>	<b>DVR Configurations</b>	<b>164</b>
6.1	Setting Up IP Cameras on GV-System	165
6.1.1	Customizing Camera Settings	168
6.2	Setting Up IP Cameras on GV-VMS	170
6.3	Remote Monitoring with Multi View	173
6.4	Remote Monitoring with E-Map	175
<b>Chapter 7</b>	<b>CMS Configurations</b>	<b>177</b>
7.1	Center V2	177
7.2	Vital Sign Monitor	179
7.3	Dispatch Server	180
<b>Chapter 8</b>	<b>Smart Device Connection</b>	<b>181</b>
<b>Chapter 9</b>	<b>GV-ASManager Connection</b>	<b>182</b>
<b>Specifications</b>		<b>185</b>
	GV-IP LPR Camera 5R	185
	GV-LPC1100	188
	GV-LPC1200 / LPR1200	192
	GV-LPC2210	196
	GV-LPC2211 / 2011	200
<b>Appendix</b>		<b>203</b>
	A. The CGI Command	203

B. RTSP Protocol Support .....	204
C. Settings for Internet Explorer 8 or later .....	205
D. Supported UMTS Protocol (3G Modem) .....	206

## Naming Definition

<b>GV-System</b>	GeoVision Analog and Digital Video Recording Software. The GV-System also refers to <b>Multicam System</b> , <b>GV-NVR</b> system, <b>GV-DVR</b> system and <b>GV-Hybrid DVR</b> system at the same time.
<b>GV-VMS</b>	GeoVision Video Management System for IP cameras.
<b>PC LPR</b>	PC LPR refers to GV-DVR LPR and GV-VMS LPR. A GV-System or GV-VMS can be turned into a GV-DVR LPR / GV-VMS LPR simply by installing the LPR Plugin and inserting an LPR Dongle. PC LPRs are capable of comparing captured license plates with the database from GV-ASManager.

## Options

Optional devices can expand your camera's capabilities and versatility. Contact your dealer for more information.

Device	Description
<b>GV-PA191 PoE Adapter</b>	<p>The GV-PA191 PoE adapter is designed to provide power and network connection to the cameras over a single Ethernet cable. The GV-PA191 PoE adapter is only available for GV-IP LPR Camera 5R and GV-LPC2211 / 2011.</p>
<b>GV-PA482 PoE Adapter</b>	<p>The GV-PA482 PoE adapter is designed to provide power and network connection to the cameras over a single Ethernet cable. The GV-PA482 PoE adapter is only available for GV-LPC1100 and GV-LPC2210.</p>
<b>GV-Relay V2</b>	<p>Working with the GV-Relay V2, the GV-IP LPR camera is capable of driving the loads of relay outputs over 5 volts. The GV-Relay V2 provides 4 relay outputs, and each can be set as normally open (NO) or normally closed (NC) independently as per your requirement.</p> <p>GV-Relay V2 is only available for GV-LPC1100 / 1200 / 2210 and GV-LPR1200.</p>
<b>GV-PoE Switch</b>	<p>For <b>GV-IP LPR Camera 5R / GV-LPC2211 / LPC2011</b>, the GV-POE Switch is designed to provide power along with network connection for IP devices.</p> <p>For <b>other models</b>, the GV-POE Switch can be used for data transmission only. It does not provide power to GV-IP LPR cameras.</p> <p>The GV-POE Switch is available in various models with different numbers and types of ports.</p>

## **Note for Connecting to GV-System / GV-VMS**

The GV-IP LPR Camera is designed to work with and record on GV-System / GV-VMS, a video management system.

Once the camera is connected to the GV-System / GV-VMS, the resolution set on the GV-System / GV-VMS will override the resolution set on the camera's Web interface. You can only change the resolution settings through the Web interface when the connection to the GV-System / GV-VMS is interrupted.

## Note for Installing Camera Outdoor

When installing the GV-IP LPR Camera outdoor, mind the following:

1. Set the camera above the junction box to prevent water from entering the camera along the cables.

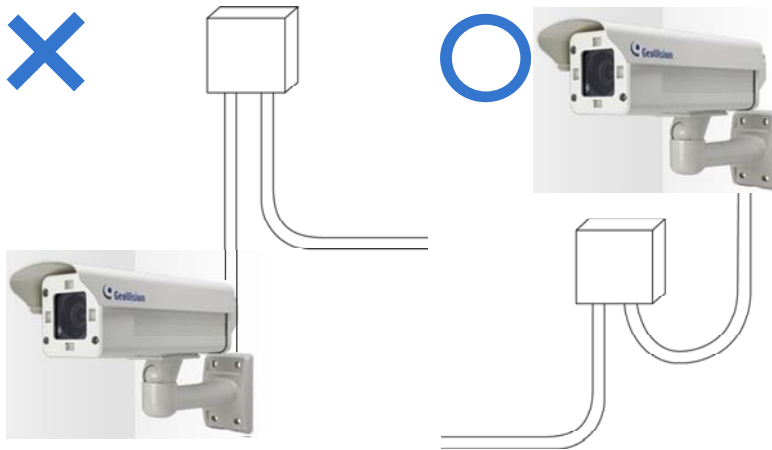

2. Waterproof the PoE, power and TV-out cables with waterproof silicon rubber or the like.

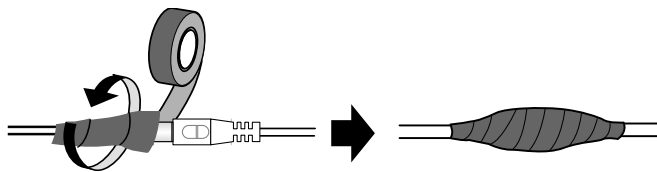

3. The camera casing can be hot due to its IR LED. Make sure you unplug the power cable and allow the camera casing to cool down before handling the camera.

## Note for Silica Gel Bags

The silica gel loses its effectiveness when the dry camera is opened. To prevent the lens from fogging up, replace the silica gel bag every time when you open the camera and conceal the gel bag in the camera within two minutes of exposing to the open air.



## Chapter 1 Introduction

### 1.1 GV-IP LPR Camera 5R



Ideal for parking lot installation, the GV-IP LPR Camera 5R is a 1.3 MP B/W network camera designed for recognition of reflective license plates on vehicles traveling at 60 km/h (37 mph) or less. With its multiple LEDs and intelligent IR, the camera is able to automatically adjust its shutter speed to the scene and produce clear license plate capture under low-light conditions. The motorized varifocal lens take the advantage of its motorized focus / zoom in that the user can remotely adjust the focus and zoom through the Web interface. It is weather proof (IP67) and also able to work in environments with temperatures ranging from -20°C (-4°F) to 50°C (122°F).

The GV-IP LPR Camera 5R can be easily configured through its Web interface and you can record and play back recordings using the free GV-NVR software included in the standard package.

### 1.1.1 Features

- 1/3" B/W progressive scan CMOS
- Motorized varifocal lens for remote focus / zoom adjustment
- Dual streams from MJPEG or H.264
- Up to 30 fps at 1280 x 1024
- Maximum speed 60 km/h (37 mph)
- Recognition for reflective license plate only
- Ingress protection (IP67)
- Vandal resistance (IK10)
- Maximum IR distance 5 M (16.4 ft)
- Built-in fan
- Defog
- Motion detection
- Privacy mask
- Text overlay
- IP address filtering
- Power supplied through PoE (PoE+, IEEE 802.3 at)
- Support for iPhone, iPad, Android and 3GPP
- ONVIF (Profile S) conformant
- 30 languages on Web interface

## 1.1.2 System Requirements

To access the camera functions and settings through Web browser, ensure your PC is in good network connection and use one of the following Web browsers:

- Microsoft Internet Explorer 7.x or later
- Google Chrome
- Mozilla Firefox
- Safari
- Microsoft Edge

---

### Note:

1. For users of **Internet Explorer 8 or later**, additional settings are required. For details, see Appendix C.
  2. With non-IE browsers,
    - A. Motion Detection, Text Overlay and two-way audio are not supported.
    - B. The Play function is only available on the live view window (Figure 3-2).
    - C. RTSP streaming must be kept as enabled. For more details, see 4.3.6 RTSP.
- 

### Compatible Software Version

Model	Firmware Version	GV-System Version	GV-VMS	GV-ASManager
GV-IR LPR	V1.00	V8.5.8.0	N/A	V4.2
Camera 5R	V1.01	V8.5.9.0 or later	V14.10 or later	V4.22 or later

**Note:** The License Plate Recognition function is only supported by GV-VMS LPR V15.10 or later.

### 1.1.3 Packing List

- GV-IP LPR Camera 5R
- Self Tapping Screw x 3
- Plastic Screw Anchor x 3
- Torx Wrench x 2
- Sun-Shield Cover Kit (1 Sun-Shield Cover, 2 Philips Head Screws, 2 Plastic Screw Spacers and 2 Hexagon Screws included)
- Silica Gel Bag
- GV-IP LPR Camera Software CD
- GV-NVR Software DVD
- GV-ASManager Software DVD
- Warranty Card

## 1.1.4 Device Installation

### 1.1.4.1 Installation Guidelines

To produce quality image and to avoid software recognition errors, make sure you adhere to the guidelines when installing your GV-IP LPR Camera 5R. See *GV-LPR Camera Installation Guide*.

### 1.1.4.2 Installing the Camera

After you have read through the installation guides and chosen an installation site, follow the steps below to install the GV-IP LPR Camera 5R.

1. Mark the installation site and drill three holes for screw anchors.
2. Insert the supplied screw anchors.
3. Secure the camera to the wall using the supplied screws.



Figure 1-1

4. Remove the protection sticker from the camera's cover.
5. Connect the camera to the network and supply power via the PoE cable. See *1.1.5 Connecting the Camera*.
6. Access the live view. See *Getting Started*, Chapter 2.
7. Based on the live view, adjust the angle, zoom and focus of the camera of the camera. For adjusting three shafts, see *1.1.6 Adjusting the Angles*. For changing zoom and focus, see *Figure 3-4* in *3.3 The Control Panel of the Live View Window*.
8. Install the sun-shield cover to the camera. For details, see *1.1.8 Installing the Sun-Shield Cover*.

### 1.1.5 Connecting the Camera

It is suggested to use GV-PA191 PoE Adapter to connect the GV-IP LPR Camera 5R to the network. Follow the steps below for connection.

1. Connect the camera's cable to the GV-PA191 PoE Adapter as illustrated below. The power and network will be supplied simultaneously.

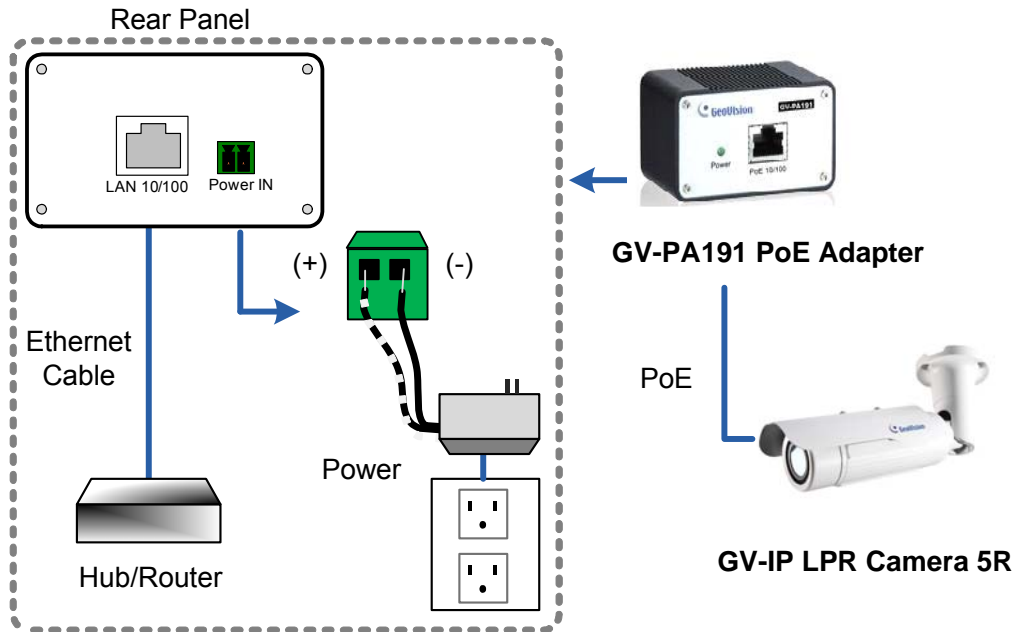

Figure 1-2

2. When the Power LED on the front panel of the GV-PA191 PoE Adapter turns green, you are ready to access the live view, adjust the image clarity and configure the basics. See *Getting Started*, Chapter 2.

---

**Note:** The GV-PA191 PoE Adapter (AC Power Adapter included) can be purchased upon request.

---

### 1.1.6 Adjusting the Angles

The GV-IP LPR Camera 5R is designed to be adjustable in three shafts for easy and flexible installation.

#### First Shaft

You can adjust the camera body by 360 degrees to the right or the left. Unscrew the panning lock screw with the torx wrench. After adjusting the camera, fasten the screw.



Figure 1-3

## Second Shaft

You can adjust the camera body up and down by 90, 112.5, 135, 157.5 or 180 degrees by using the gears inside the camera body and the camera base.

1. Unscrew the tilting lock screw with the torx wrench.



Figure 1-4

2. Hold the camera body, and move the camera base to the right to separate the camera gears.

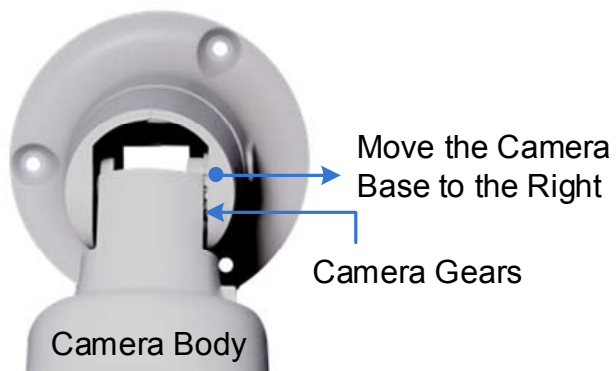

Figure 1-5

3. Adjust the angle of camera body to 90°, 112.5°, 135°, 157.5° or 180°. Then move the camera base to the left to combine the gears.



Figure 1-6

4. Fasten the tilting lock screw.



### Third Shaft

You can adjust the camera base by 360°. Unscrew the base fixing screw with the torx wrench. After adjusting the camera base, fasten the screw.



Figure 1-7

### 1.1.7 Replacing the Silica Gel Bag

Once the cover of GV-IP LPR Camera 5R is opened, you must replace the original silica gel bag with a new one.

1. Loosen the camera's cover.



*Figure 1-8*

2. Remove the silica gel bag.



*Figure 1-9*

3. Insert a new silica gel bag to the camera module and fasten the camera's cover within 2 minutes of opening the silica gel bag package.

---

**IMPORTANT:** See the Note of Silica Gel Bags at the beginning of the manual.

---

### 1.1.8 Installing the Sun-Shield Cover

After setting up the Bullet Camera, now you can install the sun-shield cover to the camera.

1. Fasten the hexagon screws either on top or below the camera.

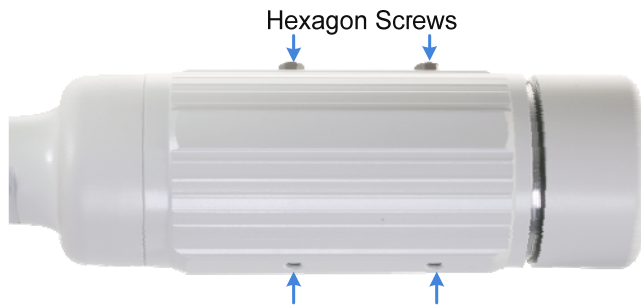

Figure 1-10

2. Put the sun-shield cover on top of hexagon screws. Make sure to aim the rear hexagon screw at the edge of the sun-shield cover's aperture for optimal sun-shield performance.

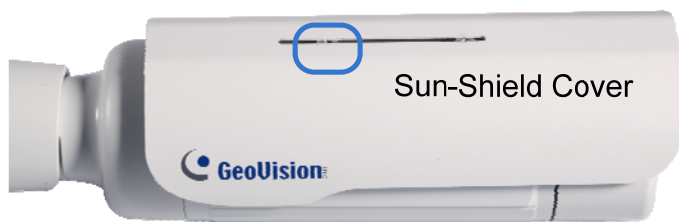

Figure 1-11

3. Fasten the Philips head screws with the plastic screw spacers.

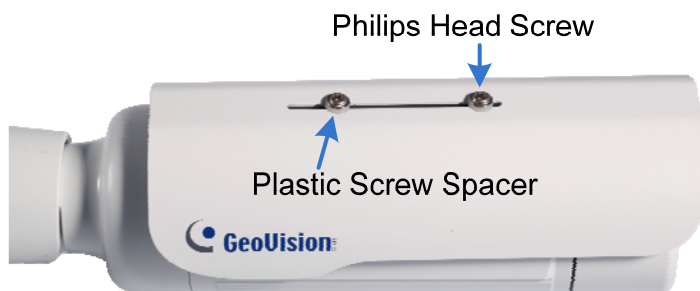

Figure 1-12

## 1.2 GV-LPC1100



The GV-LPC1100 is a 1.3 MP B/W network camera designed for recognition of reflective license plates on vehicles traveling at 120 km/h (75 mph) or less. With its multiple LEDs and intelligent IR, the camera is able to automatically adjust its shutter speed to the scene and produce clear license plate capture for one lane under low-light conditions. The motorized varifocal lens take the advantage of its motorized focus / zoom in that the user can remotely adjust the focus and zoom through the Web interface. It is weather proof (IP67) and also able to work in environments with temperatures ranging from -40°C (-40°F) to 50°C (122°F).

The GV-LPC1100 can be easily configured through its Web interface and you can record and play back recordings using the free GV-NVR software included in the standard package.

### 1.2.1 Features

- 1/3" B/W progressive scan CMOS
- Motorized varifocal lens for remote focus / zoom adjustment
- Dual streams from MJPEG or H.264
- Up to 30 fps at 1280 x 1024
- Maximum speed 120 km/h (75 mph)
- Recognition for reflective license plate only
- Ingress protection (IP67)
- Vandal resistance (IK10)
- Maximum IR distance 10 m (32.8 ft)
- DC 48V, High PoE (PoE++, 120 W)
- Built-in heater and fan
- Support for TV-out
- Support for I/O (1 in / 1 out)
- Two-way audio
- Defog
- Motion detection
- Privacy mask
- Text overlay
- IP address filtering
- Support for iPhone, iPad, Android and 3GPP
- ONVIF (Profile S) conformant
- 30 languages on Web interface

## 1.2.2 System Requirements

To access the camera functions and settings through Web browser, ensure your PC is in good network connection and use one of the following Web browsers:

- Microsoft Internet Explorer 7.x or later
- Google Chrome
- Mozilla Firefox
- Safari
- Microsoft Edge

---

**Note:**

1. For users of **Internet Explorer 8 or later**, additional settings are required. For details, see Appendix C.
  2. With non-IE browsers,
    - A. Motion Detection, Text Overlay and two-way audio are not supported.
    - B. The Play function is only available on the live view window (Figure 3-2).
    - C. RTSP streaming must be kept as enabled. For more details, see 4.3.6 RTSP.
- 

### Compatible Software Version

Model	Firmware Version	GV-System Version	GV-VMS	GV-ASManager
GV-LPC1100	V1.01	V8.5.9.0 + Patch	V14.10	V4.23
<b>Note:</b> The License Plate Recognition function is only supported by GV-VMS LPR V15.10 or later.				

### 1.2.3 Packing List

- The GV-LPC1100 camera
- Screw Anchor x 4
- Screw x 4
- Washer x 4
- Torx Wrench
- GV-PA482 PoE Adapter



- Power Adapter (DC 48V, 2.5A, 120 W)
- AC Power Cord
- Silica Gel Bag
- Adhesive tape for Silica Gel Bag
- GV-IP LPR Camera Software CD
- GV-NVR Software DVD
- GV-ASManager Software DVD
- GV-LPR Camera Installation Guide
- Warranty Card

## 1.2.4 Device Installation

### 1.2.4.1 Installation Guidelines

To produce quality image and to avoid software recognition errors, make sure you adhere to the guidelines when installing your GV-LPC1100. See *GV-LPR Camera Installation Guide*.

### 1.2.4.2 Installing the Camera

After you have read through the installation guides and chosen an installation site, follow the steps below to install the GV-LPC1100.

1. Mark the installation site and drill four holes for screw anchors.
2. Insert the supplied screw anchors.
3. Secure the camera to the wall using the supplied screws.



Figure 1-13

4. Connect the camera for power and network connection. See *1.2.5 Connecting the Camera*.
5. Access the live view. See *Getting Started, Chapter 2*.



6. Based on the live view, adjust the angle, zoom and focus of the camera. Loosen the indicated screw with the supplied torx wrench and adjust the joint.



**Tilt Adjustment**



**Pan Adjustment**



*Figure 1-14*

## 1.2.5 Connecting the Camera

GV-IP LPR Camera supports two power specifications: DC 48V, High PoE (120 W).

Follow the steps below to connect your GV-LPC1100 to power, network and other wires needed.

### 1.2.5.1 PoE Connection

Use the supplied GV-PA482 PoE Adapter to connect the camera to the power and network at the same time. Two Ethernet cables are required for the connection.

1. Inset one end of the Ethernet cable into the **PoE 10/100** port on the GV-PA482. Connect the other end of the cable to your camera.
2. Insert one end of the Ethernet cable into the **LAN 10/100** port on the GV-PA482. Connect the other end of the cable to the hub or router connecting to your computer.

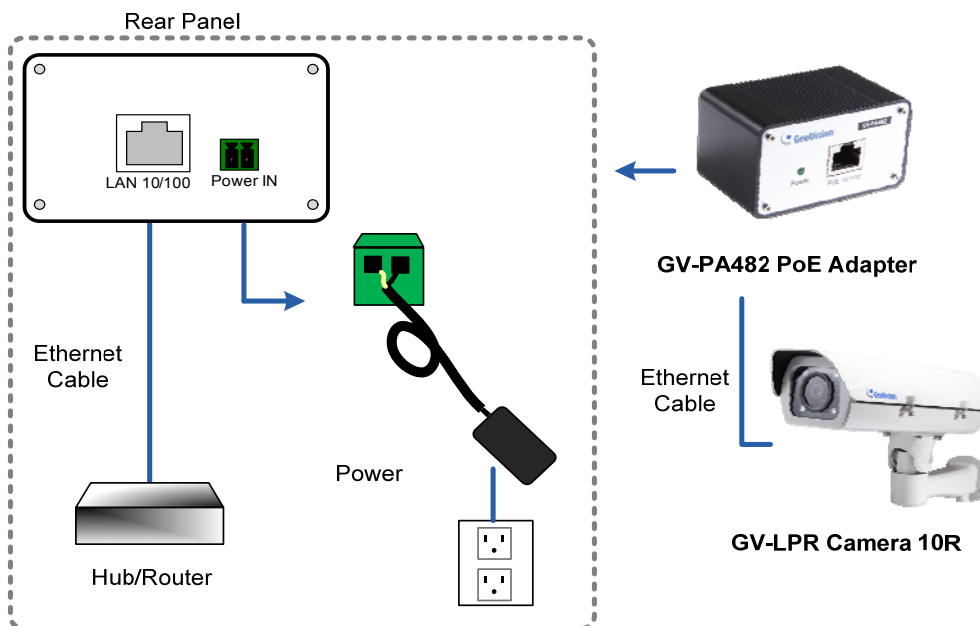

Figure 1-15

3. Insert the white wire of the supplied DC power adaptor into left-side pin of the terminal block on the GV-PA482, and the black wire to the right-side pin.
4. Attach the AC power cord to the DC power adaptor.
5. Connect the AC power cord to the power outlet.
6. When the Power LED on the front panel of the GV-PA482 turns green, you are ready to access the live view, adjust the image clarity and configure the basics. See *Getting Started*, Chapter 2.

### 1.2.5.2 Power Adapter Connection

Besides PoE connection, you can use the supplied DC power adaptor, and connect the camera to the power.

1. Plug the DC power adaptor to the 2-pin terminal block on the camera by inserting the wire with white lines to the (+) pin and the black wire to the (-) pin.

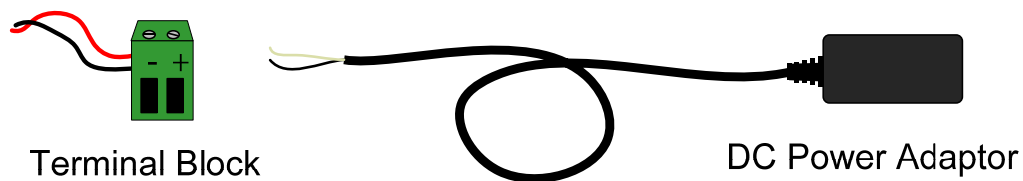

*Figure 1-16*

2. Attach the AC power cord to the DC power adaptor.
3. Connect the AC power cord to a power source.

### 1.2.5.3 Wire Definition

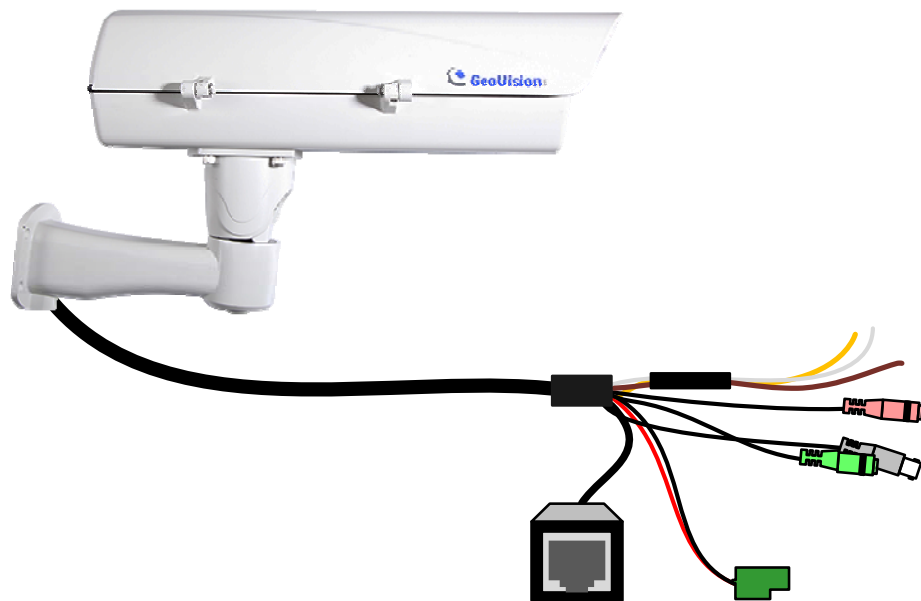

Figure 1-17

#### Camera

Wire	Definition
RJ-45	Ethernet
Black BNC	TV out
Green RCA	Audio Out
Pink RCA	Audio In
Brown	Digital Output
Yellow	Digital Input
White	GND
2-Pin Terminal Block	Power

### 1.2.5.4 I/O Device Connection

The GV-IP LPR camera supports one digital input and one digital output of dry contact.

#### Voltage Load Expansion (Optional)

The GV-IP LPR camera can only drive a maximum load of **200mA 5V DC**. To expand the maximum voltage load to **10A 250V AC, 10A 125V AC or 5A 100V DC**, connect the camera to a GV-Relay V2 module (optional product). Refer to Figure 1-8 below.

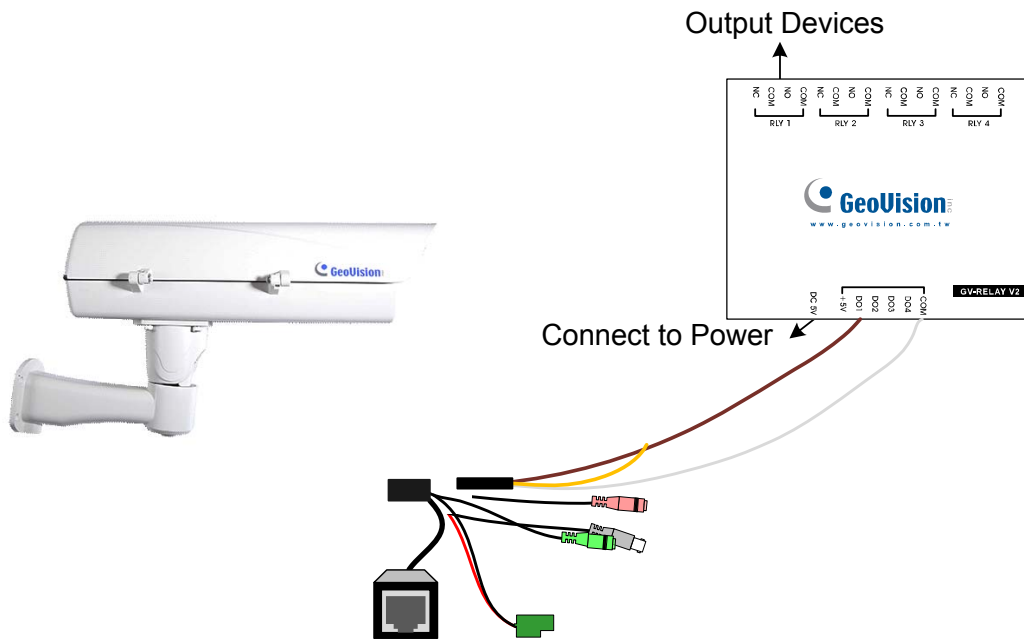

GV-Relay V2	GV-IP LPR Camera
COM	Ground (White)
DO1	Digital Out (Brown)

Figure 1-18

## 1.2.6 Replacing the Silica Gel Bag

Once the housing of GV-LPC1100 is opened, you must replace the original silica gel bag with a new one.

1. Loosen the screws holding the camera's lid with the torx wrench.



*Figure 1-19*

2. Open the camera's lid and you will find a silica gel bag attached to the interior of the lid.



*Figure 1-20*

3. Remove the silica gel bag and place a new bag back to its original position.
4. Fasten the camera's lid within 2 minutes of replacing the silica gel bag.

---

### **IMPORTANT:**

1. See the Note of Silica Gel Bags at the beginning of the manual.
  2. GV-LPC1100 currently does not support recording to Micro SD card or Mini USB function.
-

## 1.3 GV-LPC1200 / LPR1200



The camera is a 1 MP B/W network camera designed for recognition of reflective license plates on vehicles traveling at 200 km/h (124.27 mph) or less. With its multiple high-power LEDs and intelligent IR, the camera is able to automatically adjust its shutter speed to the scene and produce clear license plate capture for one lane under low-light conditions. The motorized varifocal lens take the advantage of its motorized focus / zoom in that you can remotely adjust the focus and zoom through the Web interface. It is weather proof (IP67) and also able to work in environments with temperatures ranging from -40°C (-40°F) to 50°C (122°F).

Only GV-LPR1200 is capable of recognizing the license plate numbers with the built-in LPR processor. GV-LPR1200 can compare captured license plates either with a standalone database created on GV-LPR1200, or a database downloaded from the access control software GV-ASManager. When there is a match, GV-LPR1200 will open a gate or barrier.

The camera can be easily configured through its Web interface and you can record and play back recordings using the free GV-NVR software included in the standard package.

### 1.3.1 Features

- Megapixel B/W progressive scan CCD
- Motorized varifocal lens for remote focus / zoom adjustment
- Dual streams from MJPEG or H.264
- Up to 30 fps at 1280 x 720
- Maximum speed 200 km/h (124.27 mph)
- Recognition for reflective license plate only
- Ingress protection (IP67)
- Vandal resistance (IK10 for metal casing)
- Maximum IR distance 20 m (65.6 ft)
- Built-in LPR processor to perform recognition (for GV-LPR1200 only)
- Standalone database (for GV-LPR1200 only)
- Built-in heater and fan
- Support for TV-out
- Support for I/O (2 in / 2 out)
- 10x optical zoom
- Two-way audio
- Recognized plate numbers export (for GV-LPR1200 only)
- Defog
- Motion detection
- Text overlay
- IP address filtering
- Support for iPhone, iPad, Android and 3GPP
- ONVIF (Profile S) conformant
- 30 languages on Web interface



### 1.3.2 System Requirements

To access the camera functions and settings through Web browser, ensure your PC is in good network connection and use the following Web browser:

- Microsoft Internet Explorer 7.x or later
- Google Chrome
- Mozilla Firefox
- Safari
- Microsoft Edge

---

**Note:**

1. For users of **Internet Explorer 8 or later**, additional settings are required. For details, see Appendix C.
  2. With non-IE browsers,
    - A. Motion Detection, Text Overlay and two-way audio are not supported.
    - B. The Play function is only available on the live view window (Figure 3-2).
    - C. RTSP streaming must be kept as enabled. For more details, see 4.3.6 RTSP.
- 

#### Compatible Software Version

Model	Firmware Version	Compatible Software Version		
		GV-System	GV-VMS	GV-ASManager
GV-LPC1200	V1.10	V8.6.2.0	V15.10	V4.4.0.0
GV-LPR1200	V1.10			

### 1.3.3 Packing List

- The GV-LPC1200 / LPR1200 camera
- Screw Anchor x 4



- Screw x 4



- Washer x 4



- Torx Wrench



- Power Adapter (DC 12V, 5A)
- AC Power Cord



- Silica Gel Bag
- Adhesive Tape for Silica Gel Bag
- GV-IP LPR Camera Software CD
- GV-NVR Software DVD
- GV-ASManager Software DVD
- GV-LPR Camera Installation Guide
- Warranty Card

## 1.3.4 Installing the Camera

### 1.3.4.1 Installation Guidelines

To produce quality image and to avoid software recognition errors, make sure you adhere to the guidelines when installing your camera. See *GV-LPR Camera Installation Guide*.

### 1.3.4.2 Installing the Camera

After you have read through the installation guide and chosen an installation site, follow the steps below to install the camera.

1. Mark the installation site and drill four holes for screw anchors.
2. Insert the supplied screw anchors.
3. Secure the camera to the wall using the supplied screws.



*Figure 1-21*

4. Connect the camera for power and network connection. See *1.3.5 Connecting the Camera*.
5. Access the live view. See *Getting Started, Chapter 2*.

6. Based on the live view, adjust the angle, zoom and focus of the camera. Loosen the indicated screw with the supplied torx wrench and adjust the joint.



### Tilt Adjustment



### Pan Adjustment

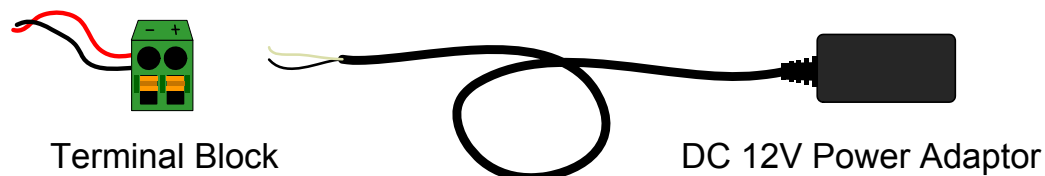

*Figure 1-22*

### 1.3.5 Connecting the Camera

Follow the steps below to connect your camera to power.

1. Use a mini-flathead screwdriver to push the orange button, plug the DC power adapter to the 2-pin terminal block connected to the camera by inserting the wire with the white line to the (+) pin and the black line to the (-) pin. Then release the push button.



*Figure 1-23*

2. Attach the AC power cord to the DC power adaptor.
3. Connect the AC power cord to a power source.

---

**Note:** It may take longer for the camera to power on when under low temperature:

- -20 ~ 0°C (-4°F ~ 32°F): about 20 minutes
  - -40 ~ -20°C (-40°F ~ 4°F): about 45 minutes
-

### 1.3.5.1 Wire Definition

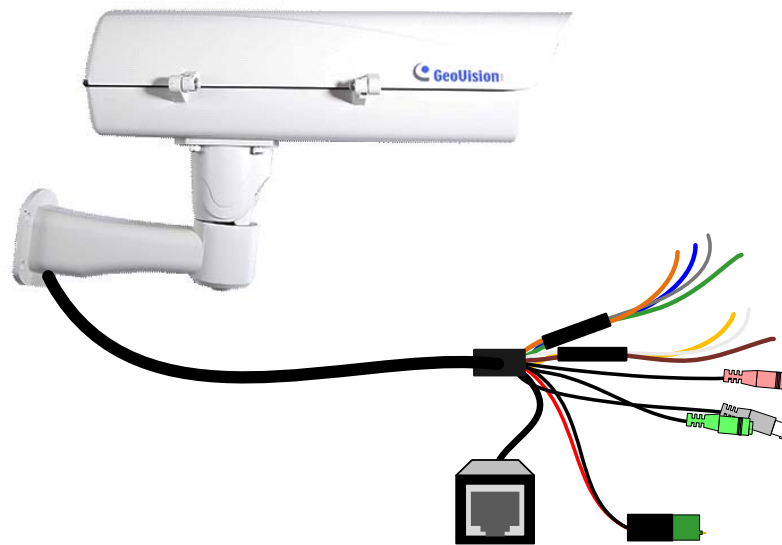

Figure 1-24

#### Camera

Wire	Definition
RJ-45	Ethernet
Black BNC	TV out
Green RCA	Audio Out
Pink RCA	Audio In
Brown	Digital Output 1
Yellow	Digital Input 1
White	GND
Orange	Digital Output 2
Blue	Digital Input 2
Green	RS-485+ (for GV-LPR1200 only)
Gray	RS-485- (for GV-LPR1200 only)
2-Pin Terminal Block	Power

### 1.3.5.2 I/O Device Connection

The GV-IP LPR camera supports two digital inputs and two digital outputs of dry contact.

#### Voltage Load Expansion (Optional)

The GV-IP LPR camera can only drive a maximum load of **125mA 5V DC**. To expand the maximum voltage load to **10A 250V AC, 10A 125V AC or 5A 100V DC**, connect the camera to a GV-Relay V2 module (optional product). Refer to Figure 1-25 below.

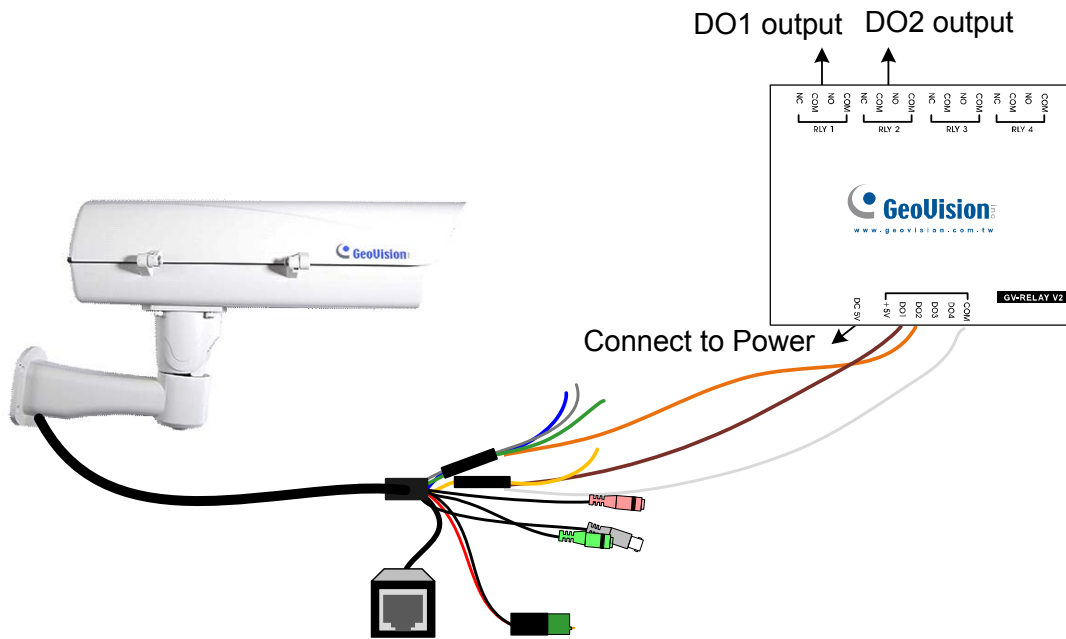

GV-Relay V2	GV-IP LPR Camera
COM	Ground (White)
DO1 / DO2	Digital Out (Brown / Orange)

Figure 1-25

### 1.3.6 Replacing the Silica Gel Bag

Once the housing of GV-LPC1200 / LPR1200 is opened, you must replace the original silica gel bag with a new one.

1. Loosen the screws holding the camera's lid with the torx wrench.



*Figure 1-26*

2. Open the camera's lid and you will find a silica gel bag attached to the interior of the lid.



*Figure 1-27*

3. Remove the silica gel bag and place a new bag back to its original position.
4. Fasten the camera's lid within 2 minutes of replacing the silica gel bag.

---

**IMPORTANT:** See the Note of Silica Gel Bags at the beginning of the manual.

---



### 1.3.7 Fitting the Battery

The camera includes a 3V lithium battery to provide power to the camera settings and real-time clock circuitry.

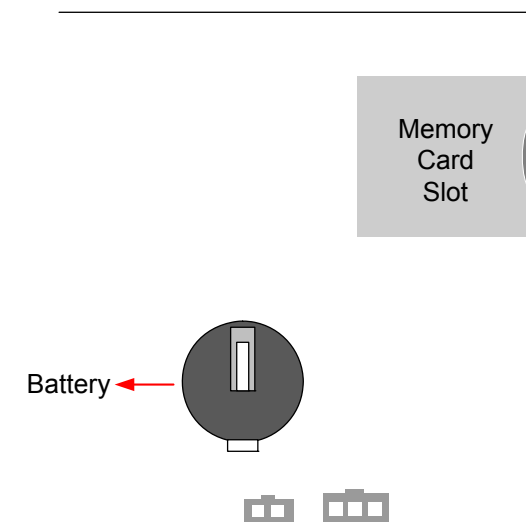

Figure 1-28

---

**IMPORTANT:**

1. Make sure the plastic insulation film under the battery is removed when you use the camera for the first time.
  2. It is recommended to replace the battery annually.
-

### 1.3.8 Installing a Mini USB Cable

To use UMTS-compatible devices, you need to prepare a Mini USB-to-USB cable with the size of the Mini USB end smaller than 1 cm for threading and install it into the camera. Follow the steps for installation.



Figure 1-29

1. Loosen 2 screws to open the camera's lid and 4 screws to remove the camera mount with the torx wrench.



Figure 1-30

2. Rotate to remove the indicated cap and remove the plug.



Figure 1-31

3. Take out the conduit connector inside the housing. Remove and disintegrate the connector. You should have 3 parts.



Figure 1-32

4. Make a side slit to part 1 with a cutter knife.

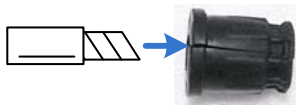

Figure 1-33

5. Thread the cable through part 3 and part 2, push the cable with the Mini USB end into part 1, thread through the camera bottom and plug it to the Mini USB port on the circuit board.

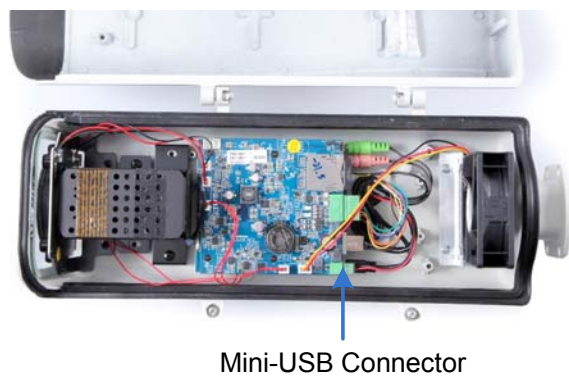

Figure 1-34

6. Re-install the connector and the cap (part 3) tightly to make sure the camera is watertight.

---

**Note:** Fill the gap between the Mini USB-to-USB cable and the conduit connector to waterproof the cable before securing the camera.



*Figure 1-35*

---

## 1.4 GV-LPC2210



GV-LPC2210 is a 2 MP color network camera designed for recognition of reflective license plates on vehicles traveling up at 120 km/h (75 mph) or less. Equipped with a Super Low Lux CMOS image sensor, the camera is capable of displaying a color live view at near darkness. Its multiple high-power LEDs and build-in intelligent IR provide clear license plate for two lanes under low-light conditions at a maximum IR distance of 20 m (65.6 ft.). The motorized varifocal lens take the advantage of its motorized focus / zoom in that the user can remotely adjust the focus and zoom through the Web interface. It is weather proof (IP67) and also able to work in environments with temperatures ranging from -40°C (-40°F) to 50°C (122°F).

The GV-LPC2210 can be easily configured through its Web interface and you can record and play back recordings using the free GV-NVR software included in the standard package.

### 1.4.1 Features

- 1/2.8" Megapixel Progressive Scan super low lux CMOS
- Motorized varifocal lens for remote focus / zoom adjustment
- Dual streams from MJPEG or H.264
- Up to 30 fps at 1920 x 1080
- Maximum speed 120 km/h (75 mph)
- Recognition for reflective license plate only
- Ingress protection (IP67)
- Vandal resistance (IK10)
- Maximum IR distance 20 m (65.6 ft)
- DC 48V, AC 24V (optional), High PoE (PoE++, 120 W)
- Built-in heater and fan
- Support for TV-out
- Support for I/O (1 in / 1 out)
- Two-way audio
- Defog
- Motion detection
- Privacy mask
- Text overlay
- IP address filtering
- Support for iPhone, iPad, Android and 3GPP
- ONVIF (Profile S) conformant
- 31 languages on Web interface

## 1.4.2 System Requirements

To access the camera functions and settings through Web browser, ensure your PC is in good network connection and use one of the following Web browsers:

- Microsoft Internet Explorer 7.x or later
- Google Chrome
- Mozilla Firefox
- Safari
- Microsoft Edge

---

### Note:

1. For users of **Internet Explorer 8 or later**, additional settings are required. For details, see *Appendix C*.
  2. For users of non-IE browsers, download **GV-Web Viewer** to access full functioning user interface. For details, see *3.1 Accessing Your Surveillance Images*.
- 

### Compatible Software Version

Model	Firmware Version	GV-System Version	GV-VMS	GV-ASManager
GV-LPC2210	V1.02	V8.6.2.0 + Patch	V14.10 + Patch	V4.35

**Note:** The License Plate Recognition function is only supported by GV-VMS LPR V15.10 or later.

### 1.4.3 Packing List

- The GV-LPC2210 camera
- Screw Anchor x 4



- Screw x 4



- Washer x 4

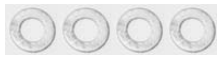

- Torx Wrench x 1



- Power Adapter (DC 48V, 2.5A, 120 W)
- AC Power Cord



- Silica Gel Bag
- Adhesive Tape for Silica Gel Bag
- GV-IP LPR Camera Software CD
- GV-NVR Software DVD
- GV-ASManager Software DVD
- GV-LPR Camera Installation Guide
- Warranty Card



## 1.4.4 Device Installation

### 1.4.4.1 Installation Guidelines

To produce quality image and to avoid software recognition errors, make sure you adhere to the guidelines when installing your GV-LPC2210. See *GV-LPR Camera Installation Guide*.

### 1.4.4.2 Installing the Camera

After you have read through the installation guides and chosen an installation site, follow the steps below to install the GV-LPC2210.

1. Mark the installation site and drill four holes for screw anchors.
2. Insert the supplied screw anchors.
3. Secure the camera to the wall using the supplied screws.



Figure 1-36

4. Connect the camera for power and network connection. See *1.2.5 Connecting the Camera*.
5. Access the live view. See *Getting Started, Chapter 2*.

6. Based on the live view, adjust the angle, zoom and focus of the camera. Loosen the indicated screw with the supplied torx wrench and adjust the joint.



### Tilt Adjustment



### Pan Adjustment



*Figure 1-37*

## 1.4.5 Connecting the Camera

The GV-LPC2210 supports two power specifications: DC 48V, High PoE (120 W).

Follow the steps below to connect your GV-LPC2210 to power, network and other wires needed.

### 1.4.5.1 PoE Connection

Use the GV-PA482 PoE Adapter to connect the camera to the power and network at the same time. Two Ethernet cables are required for the connection. For details, see *1.2.5.1 PoE Connection*.

---

**Note:** Optionally purchasing GV-PA482 PoE Adapter is required for applying PoE function.

---

### 1.4.5.2 Power Adapter Connection

Besides PoE connection, you can use the supplied DC power adaptor, and connect the camera to the power. For details, see *1.2.5.2 Power Adapter Connection*.

### 1.4.5.3 Wire Definition

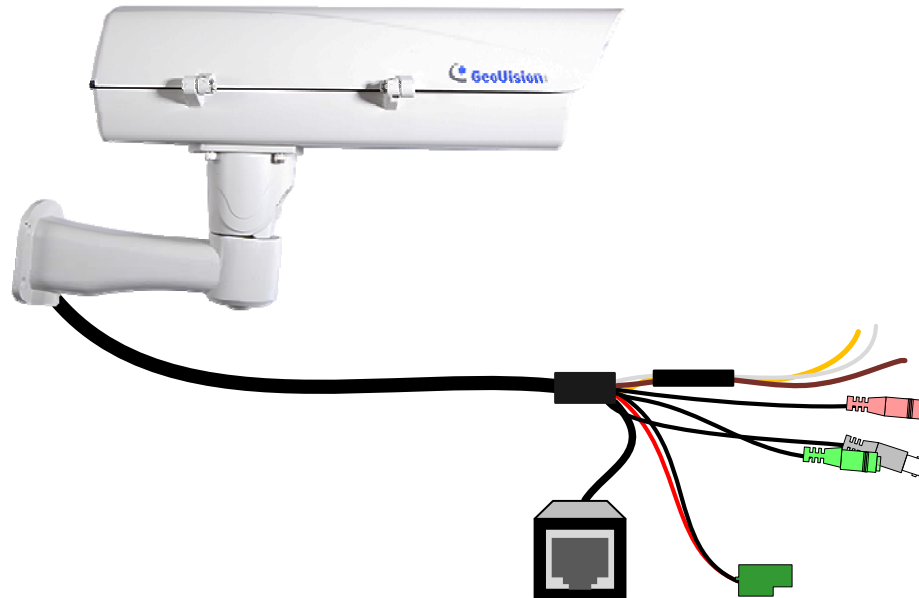

Figure 1-38

#### Camera

Wire	Definition
RJ-45	Ethernet
Black BNC	TV out
Green RCA	Audio Out
Pink RCA	Audio In
Brown	Digital Output
Yellow	Digital Input
White	GND
2-Pin Terminal Block	Power

### 1.4.5.4 I/O Device Connection

The GV-IP LPR camera supports one digital input and one digital output of dry contact.

#### Voltage Load Expansion (Optional)

The GV-IP LPR camera can only drive a maximum load of **200mA 5V DC**. To expand the maximum voltage load to **10A 250V AC, 10A 125V AC or 5A 100V DC**, connect the camera to a GV-Relay V2 module (optional product). Refer to Figure 1-39 below.

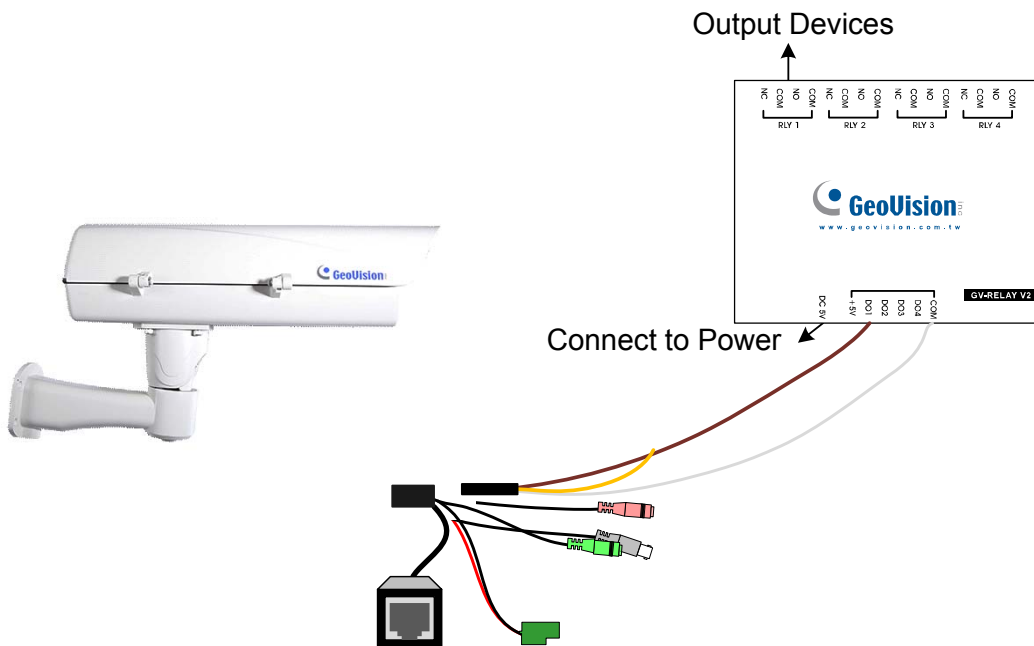

GV-Relay V2	GV-IP LPR Camera
COM	Ground (White)
DO1	Digital Out (Brown)

Figure 1-39

## 1.4.6 Replacing the Silica Gel Bag

You may also open the camera to restore the factory default settings. Once the housing of GV-LPC2210 is opened, you must replace the original silica gel bag with a new one.

1. Loosen the screws holding the camera's lid with the torx wrench.



*Figure 1-40*

2. Open the camera's lid and you will find a silica gel bag attached to the interior of the lid.



*Figure 1-41*

3. Remove the silica gel bag and place a new bag back to its original position.
4. Fasten the camera's lid within 2 minutes of replacing the silica gel bag.

---

### **IMPORTANT:**

1. See the Note of Silica Gel Bags at the beginning of the manual.
  2. GV-LPC2210 currently does not support recording to Micro SD card or Mini USB function.
-

## 1.5 GV-LPC2211/2011



### GV-LPC2211

GV-LPC2211 is a 2 MP color network camera designed for recognition of reflective license plates on vehicles traveling up at 120 km/h (75 mph) or less with extreme temperatures (-30°C ~ 50°C / -22°F ~ 122°F) resistance. It is weather proof (IP67). Equipped with a Super Low Lux CMOS image sensor, the camera is capable of displaying a color live view at near darkness. Its multiple LEDs and build-in intelligent IR provide clear license plate for two lanes under low-light conditions at a maximum IR distance of 20 m (65.6 ft.) The motorized varifocal lens take the advantage of its motorized focus / zoom in that the user can remotely adjust the focus and zoom through the Web interface. The camera also allows automatic and precise control of exposure using its P-iris, producing images with better clarity and contrast.

### GV-LPC2011

GV-LPC2011 is a 2 MP color network camera designed for recognition of reflective license plates on vehicles traveling up at 60 km/h (37 mph) or less with extreme temperatures (-30°C ~ 50°C / -22°F ~ 122°F) resistance. It is weather proof (IP67). Equipped with a Super Low Lux CMOS image sensor, the camera is capable of displaying a color live view at near darkness. Its multiple LEDs and build-in intelligent IR provide clear license plate for two lanes under low-light conditions at a maximum IR distance of 9 m (29.6 ft.). The motorized varifocal lens take the advantage of its motorized focus / zoom in that the user can remotely adjust the focus and zoom through the Web interface. The camera also allows automatic and precise control of exposure using its P-iris, producing images with better clarity and contrast.

The GV-LPC2211/2011 can be easily configured through its Web interface and you can record and play back recordings using the free GV-NVR software included in the standard package.

## 1.5.1 Features

### **GV-LPC2211**

- 1/2.8" color progressive scan super low lux CMOS
- Motorized varifocal lens for remote focus / zoom adjustment
- Dual streams from MJPEG or H.264
- Up to 30 fps at 1920 x 1080
- Maximum speed 120 km/h (75 mph)
- Recognition for reflective License Plate only
- Intelligent IR
- Day and Night function (with removable IR-cut filter)
- Megapixel lens
- Maximum IR distance 20 m (65.6 ft)
- P-iris lens for auto iris control
- Vandal resistance (IK10 for metal casing)
- Ingress protection (IP67)
- DC 12V / PoE (IEEE 802.3af)
- Wide Dynamic Range (WDR)
- 3D noise deduction
- Defog
- Motion detection
- Privacy Mask
- Text overlay
- Tampering Alarm
- IP address filtering
- Supports iPhone, iPad, Android & 3GPP
- ONVIF (Profile S) conformant
- 30 languages on Web interface



**GV-LPC2011**

- 1/2.8" color progressive scan super low lux CMOS
- Motorized varifocal lens for remote focus / zoom adjustment
- Dual streams from MJPEG or H.264
- Up to 30 fps at 1920 x 1080
- Maximum speed 60 km/h (37 mph)
- Recognition for reflective License Plate only
- Intelligent IR
- Day and Night function (with removable IR-cut filter)
- Megapixel lens
- Maximum IR distance 9 m (29.6 ft)
- P-iris lens for auto iris control
- Vandal resistance (IK10 for metal casing)
- Ingress protection (IP67)
- DC 12V / PoE (IEEE 802.3af)
- Wide Dynamic Range (WDR)
- 3D noise deduction
- Defog
- Motion detection
- Privacy Mask
- Text overlay
- Tampering Alarm
- IP address filtering
- Supports iPhone, iPad, Android & 3GPP
- ONVIF (Profile S) conformant
- 30 languages on Web interface

## 1.5.2 System Requirements

To access the camera functions and settings through Web browser, ensure your PC is in good network connection and use one of the following Web browsers:

- Microsoft Internet Explorer 7.x or later
- Google Chrome
- Mozilla Firefox
- Safari
- Microsoft Edge

---

**Note:**

1. For users of **Internet Explorer 8 or later**, additional settings are required. For details, see *Appendix C*.
  2. For users of non-IE browsers, download **GV-Web Viewer** to access full functioning user interface. For details, see *3.1 Accessing Your Surveillance Images*.
- 

### Compatible Software Version

Model	Firmware Version	GV-System Version	GV-VMS	GV-ASManager
GV-LPC2211 / 2011	V1.0	V8.6.2.0 + Patch	V14.10 + Patch	V4.35

**Note:** The License Plate Recognition function is only supported by GV-VMS LPR V15.10 or later.

### 1.5.3 Packing List

- GV-LPC2211/2011 Camera

- Sun-Shield Cover



- Silica Gel Bag x 1



- Screw for Supporting Rack x 3



- Screw Anchor x 3



- Screw for Sun-shield Cover x 2



- Washer x 2



- RJ45 Connector



- Terminal Block



- Screw for Mounting Kit x 3



- Nut for Mounting Kit x 3



- Hex Wrench



- GV-IP LPR Camera Software CD

- GV-NVR Software DVD
- GV-ASManager Software CD
- GV-LPR Camera Installation Guide
- Warranty Card

---

**Note:** Power adapter can be purchased upon request.

---

## 1.5.4 Device Installation

### 1.5.4.1 Installation Guidelines

To produce quality image and to avoid software recognition errors, make sure you adhere to the guidelines when installing your GV-LPC2211/2011. See *GV-LPR Camera Installation Guide*.

### 1.5.4.2 Installing the Camera

1. Slide the sun-shield cover onto the top of the camera. You can also secure the sun shield cover onto the back of the camera. Adjust the position of the cover before fully securing the cover with the washer and the screw.



Figure 1-42

---

#### Note:

1. The GeoVision logo on the sun-shield cover should be closer to the front of the camera.
  2. There are two holes for the screws at the back of the camera. You only need to fasten one screw to secure the sun shield cover.
-

2. Thread the Ethernet cable into the camera.
  - A. Remove the plug from the conduit connector.



*Figure 1-43*

- B. Disintegrate the removed conduit connector. Thread the Ethernet cable through the 3 parts.



*Figure 1-44*

- C. Assemble the conduit connector.



*Figure 1-45*

3. Install the camera to the wall or ceiling using the screw anchors and screws for supporting rack.



Figure1-46

4. Access the live view. See *Getting Started*, Chapter 2.

---

**IMPORTANT:** To avoid waterproofing failures, the top of the camera must be facing upward for wall mount.

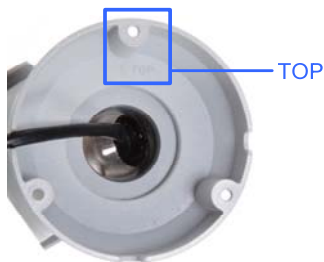

Figure 1-47

---

### 1.5.4.3 Adjusting the Angles

The GV-LPC2211/2011 is designed to be adjustable in two shafts for easy and flexible installation.

#### First Shaft

You can adjust the camera base by 360°. Unscrew the base fixing screw with the torx wrench. After adjusting the camera base, fasten the screw.



Figure 1-48

#### Second Shaft

You can adjust the camera body to the desired angle by tilting the camera module. Unscrew the tilting lock screw with the torx wrench. After adjusting the camera body, fasten the screw.



Figure 1-49

## 1.5.5 Connecting the Camera

The GV-LPC2211/2011 supports two power specifications: DC 48V, PoE (IEEE 802.3af).

Follow the steps below to connect your GV-LPC2211/20110 to power, network and other wires needed.

### 1.5.5.1 PoE Connection

You can optionally purchase GV-PA191 PoE to connect the camera to the power and network at the same time. Two Ethernet cables are required for the connection. For details, see *1.1.5 Connecting the Camera*.

### 1.5.5.2 Power Adapter Connection

Besides PoE connection, you can use a DC power adaptor, and connect the camera to the power. For details, see *1.2.5.2 Power Adapter Connection*.

### 1.5.5.3 Wire Definition

The data cable provides connections for power, ground and network access. The wires are defined below:



Figure 1-50

No.	Wire Color	Definition
1	Red	DC 12V
2	Black	Ground
3	Black (thick)	PoE, Ethernet



### 1.5.6 Replacing the Silica Gel Bag

You may open the camera to load the factory default settings. Once the housing of GV-LPC2211/2011 is opened, you must replace the original silica gel bag with a new one.

1. Remove the camera cover from the camera.



Figure 1-51

2. Loosen the camera's screws and the hexagon pillars as indicated below.



Figure 1-52

3. Take out the camera from the camera body



Figure 1-53

4. Cut the 2 silica gel bags apart with scissors and insert the new silica gel bags. The silica gel bags must be placed at the lower part of the camera body.



*Figure 1-54*

5. Secure the 2 hexagon pillars to the upper and lower holes of camera module as indicated below.



*Figure 1-55*

6. Secure the camera cover.

---

**IMPORTANT:** See the Note of Silica Gel Bags at the beginning of the manual.

---

## Chapter 2 Getting Started

### 2.1 Looking Up the IP Address

By default, your camera is assigned with an unused IP address by the DHCP server when the camera is connected to the network. This IP address remains unchanged unless you unplug or disconnect your camera from the network.

---

**Note:** If your router does not support DHCP, the default IP address will be **192.168.0.10**. In this case, it is strongly suggested to modify the IP address to avoid IP address conflict with other GeoVision IP device on the same LAN. To change the IP address, see *Changing the IP Address* later in this section.

---

Follow the steps below to find out the IP address of your camera:

1. Install the GV-IP Device Utility program from the Software DVD.

---

**Note:** The PC installed with GV-IP Device Utility must be under the same LAN with the camera you wish to configure.

---

2. On the PC desktop, select **Start**, point to **Programs** and select **GV IP Device Utility** to execute the program. The GV-IP Device Utility window appears and automatically searches for the GV-IP devices on the same LAN.

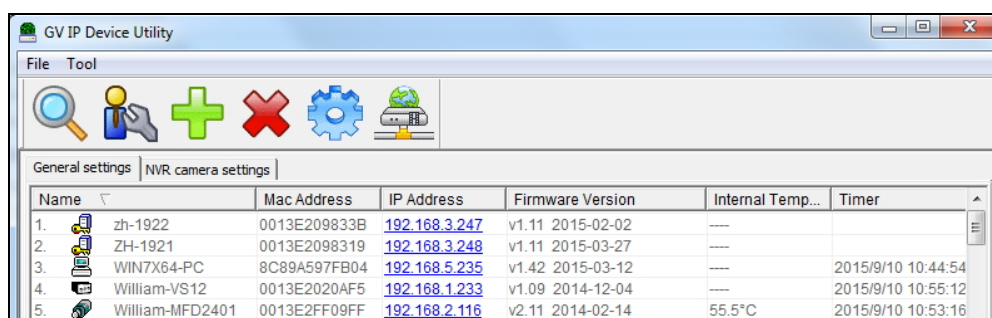
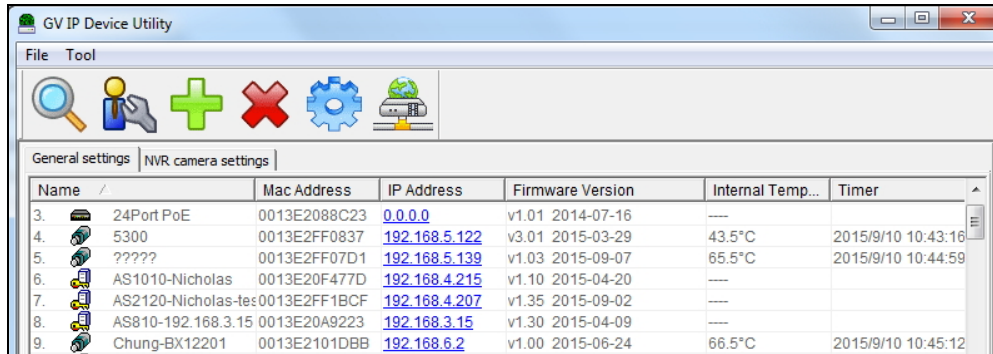

Figure 2-1

- Click the **Name** or **Mac Address** column to sort.



Name	Mac Address	IP Address	Firmware Version	Internal Temp...	Timer
3. 24Port PoE	0013E2088C23	0.0.0.0	v1.01 2014-07-16	---	
4. 5300	0013E2FF0837	192.168.5.122	v3.01 2015-03-29	43.5°C	2015/9/10 10:43:16
5. ?????	0013E2FF07D1	192.168.5.139	v1.03 2015-09-07	65.5°C	2015/9/10 10:44:59
6. AS1010-Nicholas	0013E20F477D	192.168.4.215	v1.10 2015-04-20	---	
7. AS2120-Nicholas-te	0013E2FF1BCF	192.168.4.207	v1.35 2015-09-02	---	
8. AS810-192.168.3.15	0013E20A9223	192.168.3.15	v1.30 2015-04-09	---	
9. Chung-BX12201	0013E2101DBB	192.168.6.2	v1.00 2015-06-24	66.5°C	2015/9/10 10:45:12

Figure 2-2

- Find the Mac Address of the camera, click its IP address and select **Web Page**.

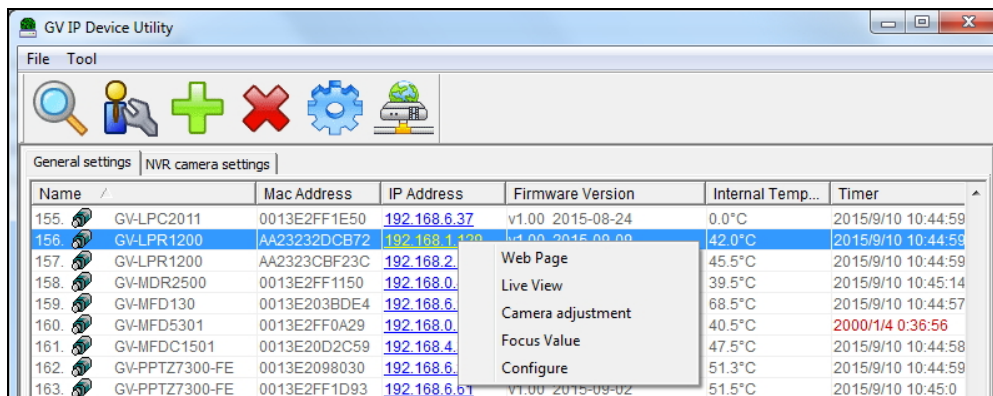

Name	Mac Address	IP Address	Firmware Version	Internal Temp...	Timer
155. GV-LPC2011	0013E2FF1E50	192.168.6.37	v1.00 2015-08-24	0.0°C	2015/9/10 10:44:59
156. GV-LPR1200	AA23232DCB72	192.168.1.120	v1.00 2015-08-24	42.0°C	2015/9/10 10:44:59
157. GV-LPR1200	AA2323CBF23C	192.168.2		45.5°C	2015/9/10 10:44:59
158. GV-MDR2500	0013E2FF1150	192.168.0		39.5°C	2015/9/10 10:45:14
159. GV-MFD130	0013E203BDE4	192.168.6		68.5°C	2015/9/10 10:44:57
160. GV-MFD5301	0013E2FF0A29	192.168.0		40.5°C	2000/1/4 0:36:56
161. GV-MFDC1501	0013E20D2C59	192.168.4		47.5°C	2015/9/10 10:44:58
162. GV-PPTZ7300-FE	0013E2098030	192.168.6		51.3°C	2015/9/10 10:44:59
163. GV-PPTZ7300-FE	0013E2FF1D93	192.168.6.61	v1.00 2015-09-02	51.5°C	2015/9/10 10:45:0

Figure 2-3

- The login page appears.
- Type the default ID and password **admin** and click **Apply** to log in.

## 2.2 Changing the IP Address

To modify the static IP address or set the camera to a public dynamic IP address, log in the Web interface to access the network setting page.

1. Open your Web browser, and type in the IP address.
  - For static network connection, type the default IP address <http://192.168.0.10>
  - For DHCP connection, follow steps in 2.1 *Looking Up the IP Address* to look up the current IP address.
2. In both Login and Password fields, type the default value **admin**. Click **Apply**.
3. In the left menu, select **Network** and then **LAN** to begin the network settings. This page appears.

Figure 2-4

4. Select **Static IP address** or **PPPoE** and type the required network information.
5. Click **Apply**. The camera is now accessible by entering the assigned IP address on the Web browser.

---

### IMPORTANT:

1. If your camera uses a public dynamic IP address via PPPoE, use the dynamic DNS Service to obtain a domain name linked to the camera's changing IP address first. For details on Dynamic IP Address and PPPoE, see 4.7.2 *Advanced TCP/IP* and 4.6.1 *LAN Configuration*.
  2. If **PPPoE** is enabled and you cannot access the camera, you may have to reset it to the factory default and then perform the network settings again. To restore the factory settings, see 5.3 *Restoring to Factory Default Settings*.
-

## 2.2 Configuring the Basics

Once you have installed and logged in the camera, you are ready to configure some of its primary settings through the Web interface:

- Date and time adjustment: see *4.7.1 Date and Time Settings*.
- Login and privileged passwords: see *4.7.3 User Account*.
- Network gateway: see *4.5 Network*.
- Camera image adjustment: see *3.3 The Control Panel of the Live View Window*.
- Video format, resolution and frame rate: see *4.1.1 Video Setting*.

## Chapter 3 Accessing the Camera

This section introduces the features of the Live View window for you to access the camera. Two types of user levels are allowed to log in the camera: Administrator and Guest. The Administrator has full access to all system configurations while the Guest can only access the live view and network status.

### 3.1 Accessing Your Surveillance Images

Follow these steps to access your surveillance images:

1. Open a Web browser.
2. Enter the IP address or domain name of the camera in the **Location/Address** field of your browser. To look up the IP address, see *2.1 Looking Up the IP Address*.

The image shows a web browser window displaying the 'IP CAMERA SETUP' page for GeoVision. The page has a light blue header with the GeoVision logo on the left and the text 'IP CAMERA SETUP' on the right. Below the header is a central login form with a light blue background and rounded corners. The form contains two input fields: 'Login:' and 'Password:'. Below these fields is an 'Apply' button. At the bottom of the page, there is a footer with the text '© 2013 GEOVISION INC. ALL RIGHTS RESERVED'.

Figure 3-1

3. Enter the login name and password.
  - The default login name and password for Administrator are **admin**.
  - The default login name and password for Guest are **guest**.
4. The live view web page is now displayed on your browser.
  - For Internet Explorer, the live view page is similar to the image in *Figure 3-3-2*.

- For Mozilla Firefox, Google Chrome, Safari, or Microsoft Edge, the live view page is similar to the image in *Figure 3-3-1*. Click **GV-Web Viewer**, type in the IP address of your camera, and click **Connect** to access the full functioning user interface.

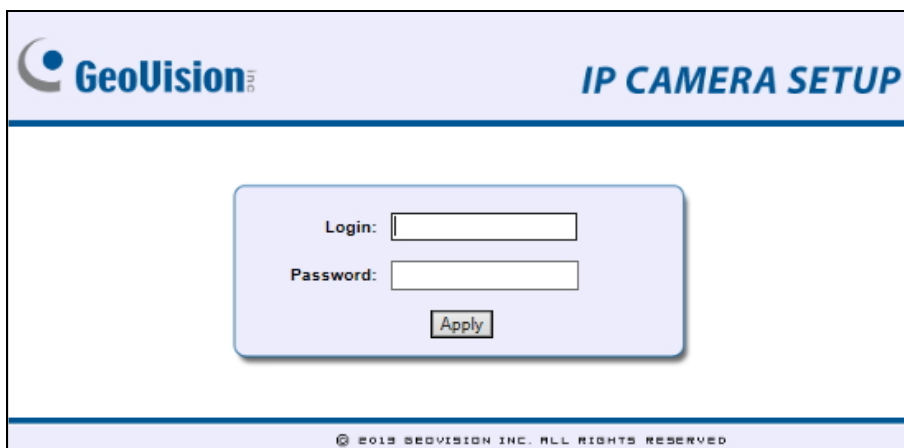
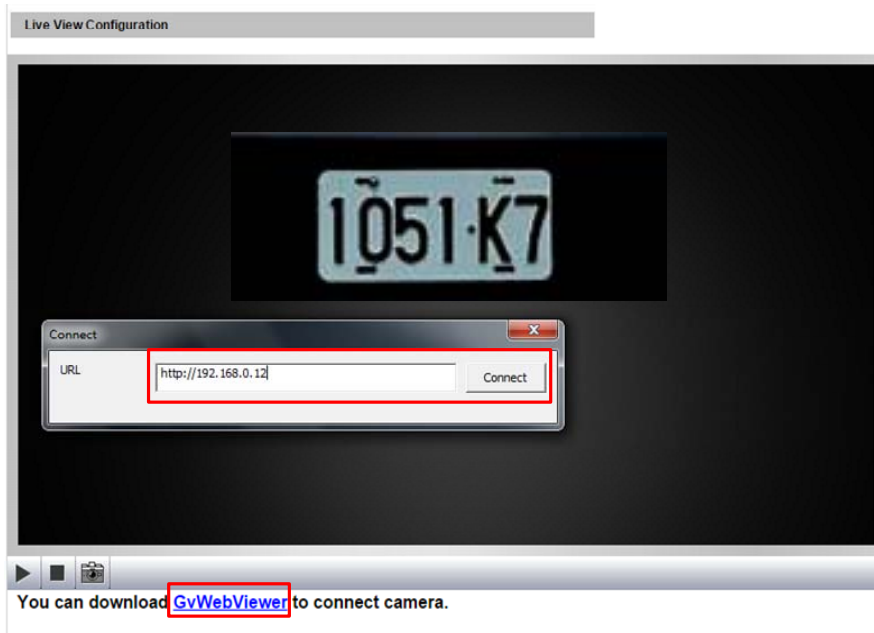

*Figure 3-2-1*

---

**Note:** To enable the updating of images in Microsoft Internet Explorer, you must set your browser to allow ActiveX Controls and perform a once-only installation of GeoVision's ActiveX component onto your computer.

---



## 3.2 The Live View Window

In the left menu, click **Live View**, and select **Camera** to see the live video.



Figure 3-2-2

No.	Name	Function
1	Play	Plays live video.
2	Stop	Stops playing video.
3	Microphone	Talks to the surveillance area from the local computer. Note this function is not available for <b>GV-IP LPR Camera 5R</b> and <b>GV-LPC2211/2011</b> .
4	Speaker	Listens to the audio around the camera. Note this function is not available for <b>GV-IP LPR Camera 5R</b> and <b>GV-LPC2211/2011</b> .
5	Snapshot	Takes a snapshot of live video. --- See 3.4 <i>Snapshot of a Live Video</i> .
6	File Save	Records live video to the local computer. --- See 3.5 <i>Video Recording</i> .

No.	Name	Function
7	Full Screen	Switches to full screen view. Right-click the image to have these options: <b>Snapshot, Full Screen, Resolution, PIP</b> and <b>PAP</b> . --- See 3.6 <i>Picture-in-Picture and Picture-and-Picture View</i> .
8	Show System Menu	Brings up these functions: <b>Alarm Notify, Video and Audio Configuration, Remote Config, Show Camera Name</b> and <b>Image Enhance</b> . --- See 3.7 <i>Alarm Notification</i> , 3.8 <i>Video and Audio Configuration</i> , 3.9 <i>Remote Configuration</i> , 3.10 <i>Camera Name Display</i> , 3.11 <i>Digital PTZ</i> , 3.12 <i>Image Enhancement</i> respectively.
9	PTZ Control	Enables the PTZ Control Panel or the Visual PTZ. The performable functions are <b>Zoom In / Out, Focus In / Out</b> , and <b>Auto Focus</b> . Note the <b>Auto Focus</b> function only works for GV-IP LPR Camera 5R and GV-LPC1100 while other LPR camera models can automatically focus.
10	I/O Control	Enables the I/O Control Panel or the Visual Automation. Note this function is only supported by cameras with I/O function. --- See 3.12 <i>I/O Control</i> .
11	Recognition Result	Displays the snapshots of the recognition results when the camera recognizes a license plate. Note this function is only supported by GV-LPR1200.

### 3.3 The Control Panel of the Live View Window

To open the control panel of the Live View window, click the arrow button on top of the viewer. You can access the following functions by using the right and left arrow buttons on the control panel.

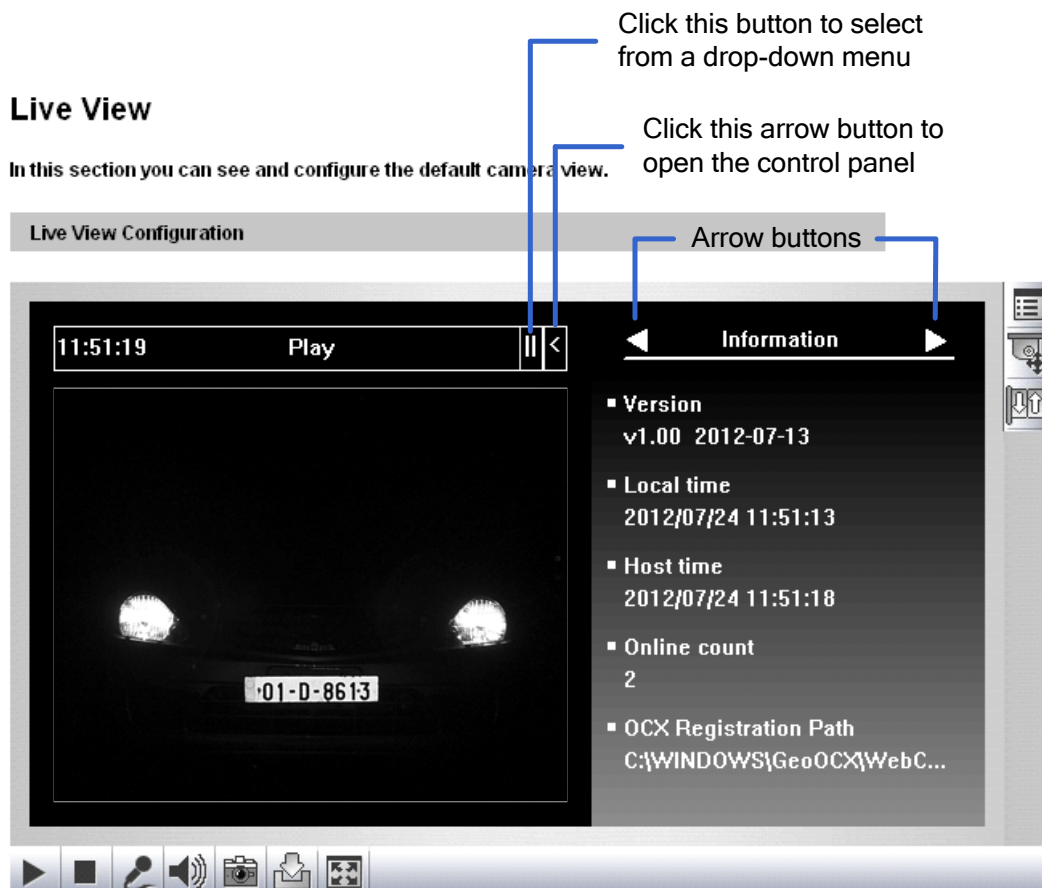

Figure 3-3

**[Information]** Displays the version of the camera, local time of the local computer, time of the camera, the number of users logging in to the camera and the OCX registration path.

**[Video]** Displays the current video codec, resolution and data rate.

**[Audio]** Note this function is only supported by cameras with audio function. Displays the audio data rates when the microphone and speaker devices are enabled.

**[I/O Control]** Note this function is only supported by cameras with I/O function. Provides a real-time graphic display of the input and output status. You can force the output to be triggered by double-clicking its icon.

**[Alarm Notify]** Displays the captured images by motion detection. For this function to work, you must configure the Alarm Notify settings first. See 3.7 *Alarm Notification*.

**[Camera Adjustment]** Adjusts the image quality settings. Click **Save** to store the changes to the settings.

**GV-IP LPR Camera 5R /**

**GV-LPC1100**

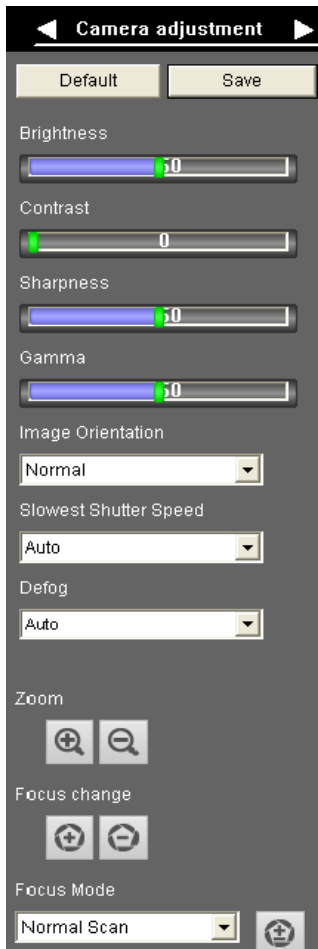

**GV-LPC1200 /**

**GV-LPR1200**

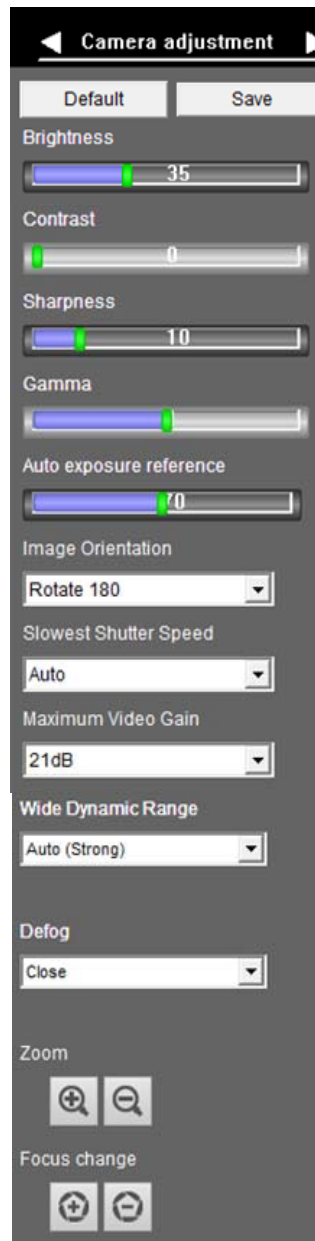

**GV-LPC2210 / 2211 /**

**2011**

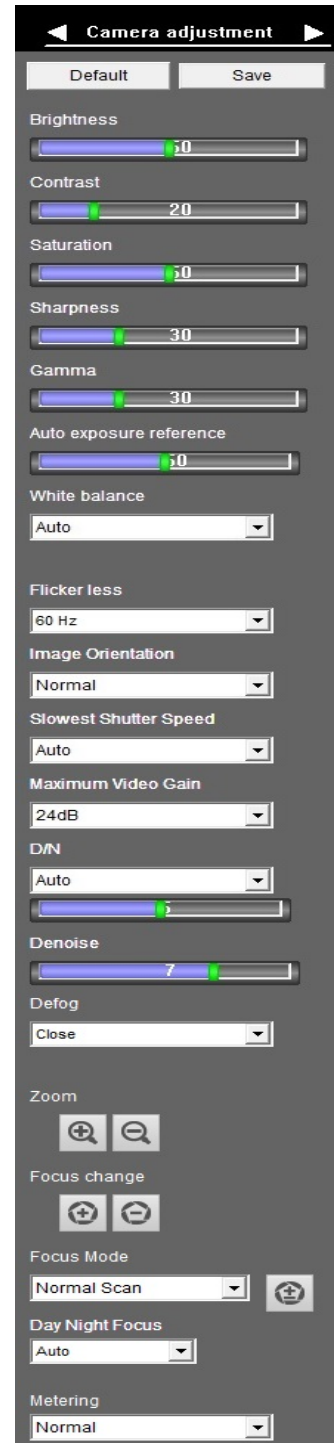

Figure 3-4

- **Brightness:** Adjusts the brightness of the image.
- **Contrast:** Adjusts the relative differences between one pixel and the next.
- **Saturation:** Adjusts the saturation of the image. Note this function is only available for **GV-LPC2210 / 2211 / 2011**.
- **Sharpness:** Adjusts the sharpness of the image.
- **Gamma:** Adjusts the relative proportions of bright and dark areas.
- **Auto Exposure Reference:** Adjusts the exposure of the image. Note this function is only available for **GV-LPC1200, GV-LPR1200** and **GV-LPC2210 / 2211 / 2011**.
- **White balance:** The camera automatically adjusts the color to be closest to the image you are viewing. You can choose one of the four presets: **Auto, Outdoor, Indoor,** and **Fluorescent**. You can also choose **Manual** to adjust the white balance manually. Note this function is only available for **GV-LPC2210 / 2211 / 2011**.
- **Flicker less:** The camera automatically matches the frequency of your camera's image to the frequency of indoor light sources, e.g. fluorescent lighting. You can also select 50 Hz or 60 Hz manually. If these don't match, faint light and dark bars may appear in your images. Check the power utility to determine which frequency is used. Note this function is only available for **GV-LPC2210 / 2211 / 2011**.
- **Image Orientation:** Adjusts the orientation of image by selecting **Normal, Horizontal Mirror, Vertical Flip** and **Rotate 180** on the Live View window.
- **Slowest Shutter Speed:** Sets the shutter speed. Shutter speed controls the amount of the lights enters the image sensor and directly impacts the quality of image presentation. A slow shutter speed allows higher light exposure that creates a brighter overall image by blurring moving objects and bringing out background details, and a faster shutter speed lowers color and image clarity in order to capture motions.











The minimum shutter speed ranges from 1/500 to 1/8000 sec.

- **GV-IP LPR Camera 5R, GV-LPC1100,** from 1/250 to 1/2000 sec.
- **GV-LPR1200, GV-LPC1200 / 2211 / 2210 / 2011,** from 1/120 to 1/2000.

Select **Auto** for automatic shutter control or select a shutter speed value.

- **Maximum Video Gain:** Changes the maximum gain level. Note this function is only available for **GV-LPR1200** and **GV-LPC1200 / 2210 / 2211 / 2011**.
- **D/N:** Note this function is only available for **GV-LPC2210 / 2211 / 2011**. Select **Auto** for automatic switch between day mode and night mode depending on the amount of light detected. Select **Black and white** to switch the camera to night mode. Select **Color** to switch the camera to day mode. The value 10 is the most light-sensitive. Only for **GV-LPC 2210**, select **Trigger by Input** to switch between day mode and night

mode once the input device (e.g. sensor or button) is triggered. See the same D/N setting in *D/N, Special Video Settings, 4.1.1.1 Streaming 1/2*.

- **Denoise:** Reduces image noise especially under low-light conditions. The higher the denoise value, the stronger the effect. Note this function is only available for **GV-LPC2210 / 2211 / 2011**.
- **Defog:** Select **Auto** to automatically enhance the visibility of images. Select **Close** to disable the function.
- **Wide Dynamic Range:** Adjusts and generates clear live view when the scene contains very bright and very dark areas at the same time. Select **Auto (Strong)** to bring out details in the dark areas of the scene, select **Auto (Weak)** to bring out less details in the dark areas and at the same time keep the bright areas from overexposure, or select **Auto (Normal)** for a balanced effect. Select **Close** to disable the function. Note this function is only available for **GV-LPC / LPR1200**. See *4.5.3 WDR Settings* to set a schedule for different image adjustments.
- **Zoom:** Click the **Zoom In**  and **Zoom Out**  buttons to adjust the apparent distance of the scene.
- **Focus Change:** Click the **Focus In**  and **Focus Out**  buttons to adjust the focus. To focus automatically, click the **Focus Mode**  button.
- **Focus Mode:** Select **Normal Scan**, **Regional Scan** or **Full Scan** and then click the **Start**  button to automatically adjust the camera focus. The **Normal Scan** mode focuses the camera the fastest. The **Regional Scan** mode focuses the area selected on the live view. The **Full Scan** mode performs a detailed checkup and applies the best focus. Note this function is only available for **GV-IP LPR Camera 5R and GV-LPC1100 / 2210**.
- **Day Night Focus:** Note this function is only available for **GV-LPC2210 / 2211 / 2011**. Saves focus settings for day mode and night mode. Select **Auto** to automatically focus. To configure fixed settings for day mode and night mode, select **Manual** and follow the steps below:
  - Make sure the **D/N** is in **Auto** mode for the best effect. The following focus setting will be applied to the current D/N mode.
  - Adjust the focus using the **Focus In**  and **Focus Out**  buttons and/or the **Focus Mode** function.
  - Click **Day Mode Save**  or the **Night Mode Save**  button depending on the current D/N mode.

- **Metering:** Controls the camera's exposure. Select **Normal** for the camera to adjust exposure based on the full live view. Select **Regional Metering** for the camera to adjust exposure of specified zones. Draw directly on the live view and a block marked with "AE (automatic exposure)" appears. You can establish up to 4 zones. To remove the block, right-click the block and select **Delete**. Note this function is only available for **GV-LPC2210 / 2211 / 2011**.

**[Internal Temperature]** Shows the current internal temperature of the camera and the normal temperature range.

**[Download]** Allows you to install programs from the hard drive.

## 3.4 Snapshot of a Live Video

To take a snapshot of live video, follow these steps:

1. Click the **Snapshot** button (No. 5, Figure 3-2). The Save As dialog box appears.
2. Specify **Save in**, type the **File name**, and select **JPEG** or **BMP** for **Save as Type**. You may also choose to display the camera name and/or the date, the text color and image quality for the snapshot.
3. Click the **Save** button to save the image in the local computer.

---

**Note:** You can also obtain a snapshot of the live view without logging in the user interface by executing the CGI command. See *Appendix A*.

---

## 3.5 Video Recording

You can record live video for a certain period of time to your local computer.

1. Click the **File Save** button (No. 6, Figure 3-2). The Save As dialog box appears.
2. Specify **Save in**, type the **File name**, and move the **Time Period** scroll bar to specify the time length of the video clip from 1 to 5 minutes.
3. Click the **Save** button to start recording.
4. To stop recording, click the **Stop** button (No. 2, Figure 3-2).

## 3.6 Picture-in-Picture and Picture-and-Picture View

The Live View window provides two types of close-up views: **Picture-in-Picture (PIP)** and **Picture-and Picture (PAP)**. The two views are useful to provide clear and detailed images of the surveillance area.

### Picture-in-Picture View

With the Picture-in-Picture (PIP) view, you can crop the video to get a close-up view or zoom in on the video.



Figure 3-5

1. Right-click the live view and select **PIP**. An inset window appears.
2. Click the insert window. A navigation box appears.
3. Move the navigation box around in the inset window to have a close-up view of the selected area.
4. To adjust the navigation box size, move the cursor to any of the box corners, and enlarge or diminish the box.
5. To exit the PIP view, right-click the image and click **PIP** again.



### Picture-and-Picture View

With the Picture-and-Picture (PAP) view, you can create a split video effect with multiple close-up views on the image. A total of 7 close-up views can be defined.



Figure 3-6

1. Right-click the live view and select **PAP**. A row of three inset windows appears at the bottom.
2. Draw a navigation box on the image, and this selected area is immediately reflected in one inset window. Up to seven navigation boxes can be drawn on the image.
3. To adjust a navigation box size, move the cursor to any of the box corners, and enlarge or diminish the box.
4. To move a navigation box to another area on the image, drag it to that area.
5. To add, display/hide or to change the frame color of the navigation boxes, right-click the live view, select **Mega Pixel Setting** and click one of these options:
  - **Enable Add-Focus-Area Mode:** Allows the user to add navigation boxes to the image.
  - **Display Focus Area of PAP Mode:** Displays or hides the navigation boxes on the image
  - **Set Color of Focus Area:** Changes the color of the box frames.
6. To delete a navigation box, right-click the desired box, select **Focus Area of PAP Mode** and click **Delete**.
7. To exit the PAP view, right-click the image and click **PAP** again.

### 3.7 Alarm Notification

When a motion is detected, you can be alerted by a pop-up live video and view up to four captured images.



Figure 3-7

To configure this function, click the **Show System Menu** button (No. 8, Figure 3-2), and select **Alarm Notify**. This dialog box appears.

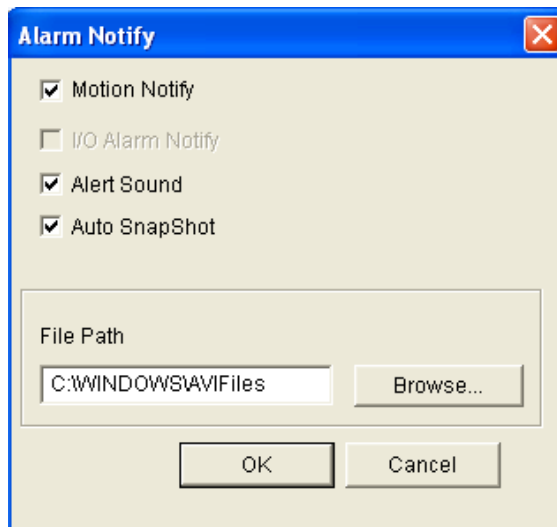

Figure 3-8

- **Motion Notify:** Once motion is detected, the captured images are displayed on the control panel of the Live View window.
- **I/O Alarm Notify:** Once the input device is triggered, the captured images are displayed on the control panel of the Live View window. For this function to work, the Administrator needs to install the input device properly. See 4.2.1 Input Setting. Note this function is only available for cameras with I/O function.
- **Alert Sound:** Activates the computer alarm on motion.
- **Auto Snapshot:** The snapshot of live video is taken every 5 seconds on motion.
- **File Path:** Assigns a file path to save the snapshots.

## 3.8 Video and Audio Configuration

You can enable the microphone and speaker for two-way audio communication and adjust the set the number of frames to keep for live view buffer.

Click the **Show System Menu** button (No. 8, Figure 3-2), and select **Video and Audio Configuration**.

- Camera:** Sets the number of frames to keep in live view buffer. Keeping more frames for live view buffer can ensure a smooth live view, but the live view will be delayed for the number of seconds specified.

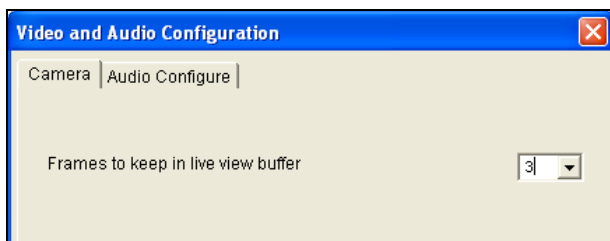

Figure 3-9

- Audio Configure:** You can enable the microphone and speaker and adjust the audio volume. Note this setting is not available for **GV-IP LPR Camera 5R** and **GV-LPC2211 / 2011**.

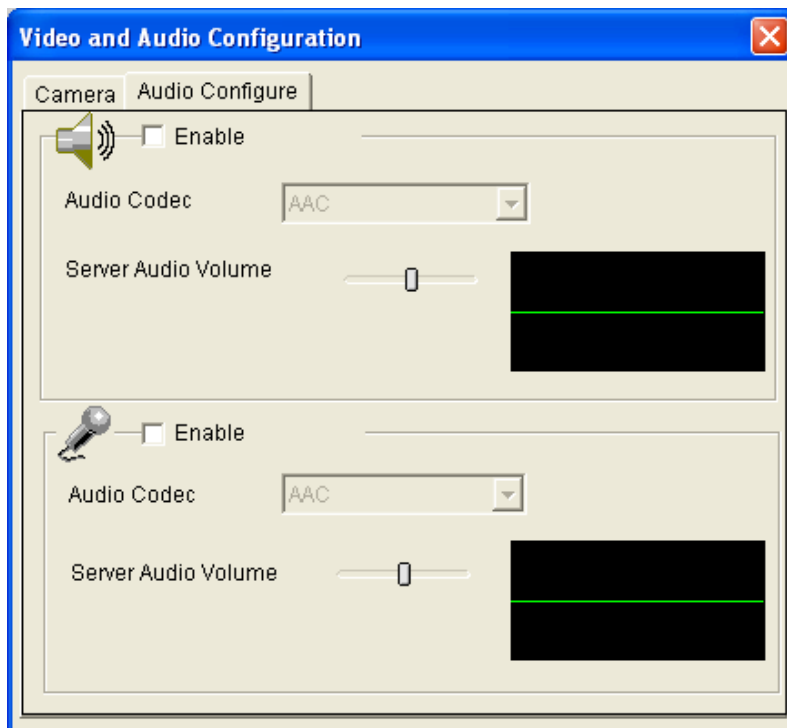

Figure 3-10

## 3.9 Remote Configuration

You can upgrade the device firmware over the network. Click the **Show System Menu** button (No. 8, Figure 3-2), and select **Remote Config**. The Remote Config dialog box will appear.

**[Firmware Upgrade]** In this tab, you can upgrade the firmware over the network. For details, see *Chapter 5 Advanced Applications*.

## 3.10 Camera Name Display

To display the camera name on the image, click the **Show System Menu** button (No. 8, Figure 3-2), and select **Show Camera Name**.

## 3.11 Image Enhancement

To enhance the image quality of live video, click the **Show System Menu** button (No. 8, Figure 3-2), and select **Image Enhance**. This dialog box appears.

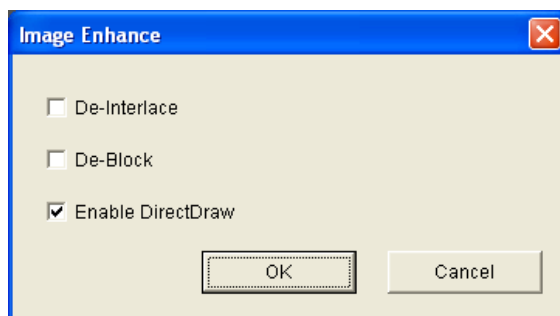

Figure 3-11

- **De-Interlace:** Convert the interlaced video into non-interlaced video.
- **De-Block:** Remove the block-like artifacts from low-quality and highly compressed video.
- **Enable DirectDraw:** Activate the DirectDraw function.

## 3.12 Digital PTZ

Digital PTZ allows non-PTZ cameras to simulate PTZ movements on live view. Note this function is only supported by **GV-LPC2211 / 2011**.

1. Click live view and select **Digital PTZ**.

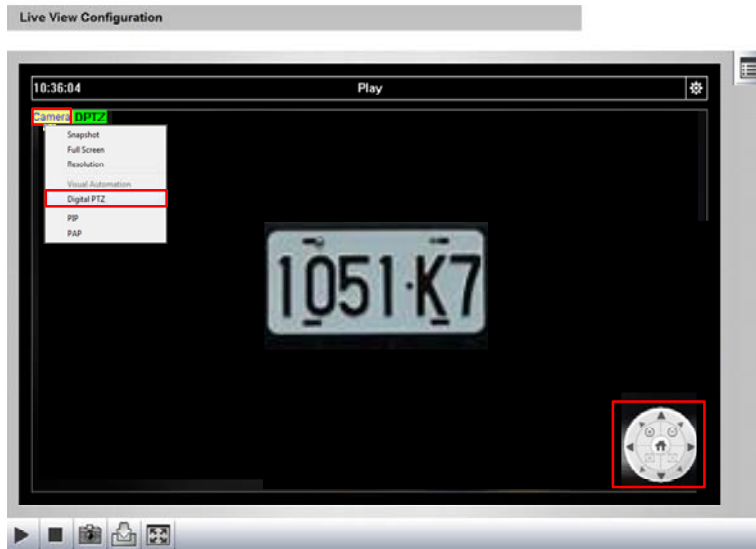



Figure 3-12

2. To zoom in / out, move the cursor to the control panel at left corner and click the corresponding buttons. To bring the view back to its default image, click **Home**.
3. To adjust the view, zoom the image first and then click  to move your camera up, down, left, right, left up, left down, right up or right down.]

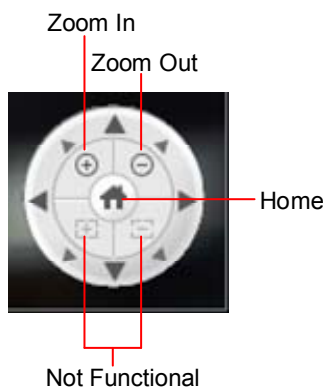

Figure 3-13

---

**Note:** The Focus In / Out and the speed level are not functional for Digital PTZ.

---

### 3.13 I/O Control

Note this function is only supported by cameras with I/O function. The I/O Control window provides a real-time graphic display of camera status, I/O status, and alarm events. Additionally, you can remotely force output to be triggered.

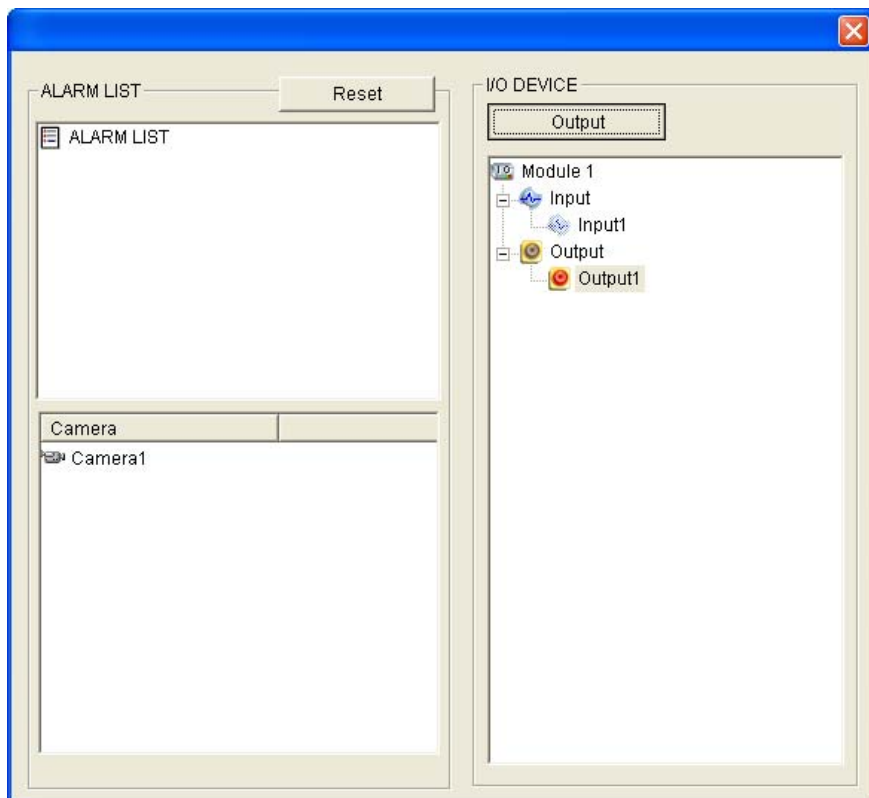

Figure 3-14

- To display the I/O control window, click the **I/O Control** button (No. 11, Figure 3-2) and select **I/O Control**.
- The Alarm List is displayed in three levels. The first level indicates date, the second indicates time, and the third indicates alarm ID. Clicking the **Reset** button will clear the list.
- To trigger an output device, highlight an output and then click the **Output** button.

### 3.14 Visual Automation

Note this function is only supported by cameras with I/O function. The Visual Automation allows you to change the current state of the electronic device by simply clicking on its image, e.g. turning the light ON. This feature is only available when the Visual Automation is set ahead by the Administrator. For details, see *4.1.5 Visual Automation*.



Figure 3-15

- To access this feature, click the **I/O Control** button (No. 10, Figure 3-2) and select **Visual Automation**.
- To change the style of the set areas, click the green **I/O** button on the top left corner. You will have these options:
  - **Show All:** Displays all set areas.
  - **Rect Float:** Embosses all set areas.
  - **Set Color:** Changes the frame color of all set areas

## Chapter 4 Administrator Mode

The Administrator can access and configure your camera over the network. The configuration categories include: **Video and Motion**, **Events and Alerts**, **Monitoring**, **Recording Schedule**, **Network** and **Management**.

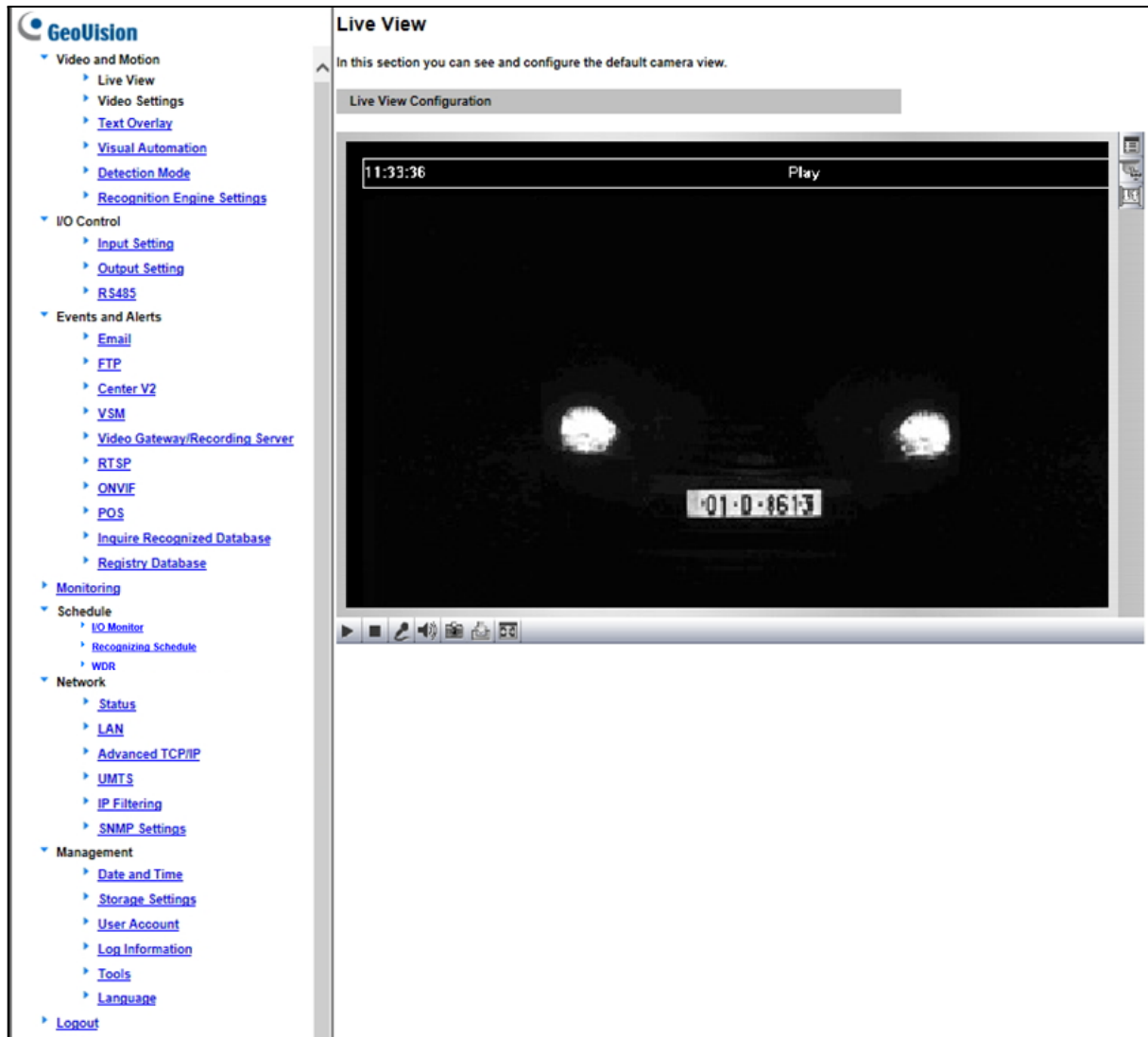

Figure 4-1



## Corresponding Section for Configuration Menu

Find the topic of interest by referring to the indicated section.

4.1 Video and Motion	<ul style="list-style-type: none"> <li>4.1.1 Video Settings</li> <li>4.1.2 Motion Detection / Detection Mode</li> <li>4.1.3 Privacy Mask</li> <li>4.1.4 Text Overlay</li> <li>4.1.5 Tampering Alarm</li> <li>4.1.6 Visual Automation</li> <li>4.1.7 Recognition Engine Settings</li> </ul>
4.2 I/O Control	<ul style="list-style-type: none"> <li>4.2.1 Input Settings</li> <li>4.2.2 Output Settings</li> <li>4.2.3 RS485</li> </ul>
4.3 Events and Alerts	<ul style="list-style-type: none"> <li>4.3.1 Email</li> <li>4.3.2 FTP</li> <li>4.3.3 Center V2</li> <li>4.3.4 VSM (Vital Sign Monitor)</li> <li>4.3.5 GV-Video Gateway / GV-Recording Server</li> <li>4.3.6 RTSP</li> <li>4.3.7 ONVIF</li> <li>4.3.8 POS</li> <li>4.3.9 Inquire Recognized Database</li> <li>4.3.10 Registry Database</li> </ul>
4.4 Monitoring	<ul style="list-style-type: none"> <li>4.4.1 Monitoring Settings</li> </ul>
4.5 Schedule	<ul style="list-style-type: none"> <li>4.5.1 I/O Monitor Settings</li> <li>4.5.2 Recognizing Schedule Settings</li> <li>4.5.3 WDR</li> </ul>
4.6 Network	<ul style="list-style-type: none"> <li>4.6.1 LAN Configuration</li> <li>4.6.2 Advanced TCP/IP</li> <li>4.6.3 UMTS</li> <li>4.6.4 IP Filtering</li> <li>4.6.5 SNMP Settings</li> </ul>
4.7 Management	<ul style="list-style-type: none"> <li>4.7.1 Date and Time Settings</li> <li>4.7.2 Storage Settings</li> <li>4.7.3 User Account</li> <li>4.7.4 Log Information</li> <li>4.7.5 Tools</li> <li>4.7.6 Language</li> </ul>

## 4.1 Video & Motion

The camera supports dual streams, Streaming 1 and Streaming 2, which allow separate codec and resolutions settings for a single video transmission. In a bandwidth-limited network, such as mobile phone surveillance, this dual-stream feature allows you to view live video in lower resolution (Streaming 2), and record in highest resolution (Streaming 1) at the same time.

Comparison between Stream 1 and Stream 2:

Video Setting Options	Stream 1	Stream 2
<b>Video Signal Type</b>	Different codec, resolutions and frame rates can be applied to Stream 1 and 2.	
<b>Watermark Setting</b>	Yes	Not configurable. Settings in Stream 1 will be automatically applied to Stream 2.
<b>Audio Codec</b>		
<b>Video Entropy Coding Setting</b>		
<b>TV Out Setting</b>		
<b>Status LED Control</b>		
<b>Special View Setting</b>		
<b>Note:</b> <ol style="list-style-type: none"> <li><b>Watermark Setting</b> is not available in GV-LPC2211 / 2011.</li> <li><b>Special View Setting</b> is only available in GV-LPC2210 / 2211 / 2011.</li> <li><b>H264 Video Entropy Coding Setting</b> is only available in GV-LPC2210.</li> </ol>		

## 4.1.1 Video Settings

### 4.1.1.1 Streaming 1/2

### Video Settings

In this section you can define compression art, broadcasting method and privacy mask.

**Connection template**

Fast (LAN, T1, Wireless 802.11a/g, ADSL-high speed..) ▾

**Video Signal Type**

In this section you can configure camera's video signal, also the resolution and frame per second to be transmitted through the network

Video Format  ▾

Resolution	Frame per second
<input type="text" value="1920*1080 (16:9)"/> ▾	<input type="text" value="30"/> ▾

**Bandwidth Management**

In this section you can configure the bit rate used by video stream. When VBR (Variable Bit Rate) is selected, consistent image quality is achieved at the cost of varying bit rate. To set a consistent bit rate at the cost of varying image quality, select CBR (Constant Bit Rate).

<input checked="" type="radio"/> VBR	Quality <input type="text" value="Good"/> ▾	Maximal Bit Rate <input type="text" value="8"/> ▾ Mbit
<input type="radio"/> CBR	Maximal Bit Rate <input type="text" value="8192 Kbps"/> ▾	

**GOP Structure and Length**

In this section you can configure the composition of the video stream (GOP structure). Using I-Frame only will significantly increase the video quality as well as the bandwidth.

Group of Picture(GOP) Size  ▾ (seconds)

**H264 Video Entropy Coding Setting**

In this section you can decide Video entropy coding for H.264 codec

H.264 Entropy Encoding  ▾

**Text Overlay Settings**

In this section you can set up texts to be overlaid on live view when viewing via GeoVision software.

Camera Name

Overlay with:

- Camera Name
- Date
- System Time
- Name of the associated digital input

Figure 4-2A

**Text Overlay Settings (OSD)**

In this section you can set up texts to be overlaid on live view.

Camera Name

Font Size

Overlay with:

Camera Name

Date

System Time

---

**Watermark Setting**

In this section you can set Watermark function.

Enable

---

**TV-Out**

Signal Format  NTSC  PAL  Disable

---

**LED Control**

Ready LED  Enable  Disable

---

**Special View Setting**

**Additional functions for Live View**

D/N

<input checked="" type="radio"/>	Auto	Sensitivity	<input type="text" value="5"/>
<input type="radio"/>	Black and White		
<input type="radio"/>	Color		
<input type="radio"/>	Triggered by Input.		

---

BLC  Off  On

---

IR Light  Auto  Off

Figure 4-2B

**[Name]**

Rename the camera. The camera name will appear on the Live View. To display the camera name, see 3.10 Camera Name Display.

**[Connection Template]**

Select the type of your network connection. Unless you select **Customized**, this option will automatically bring up the recommended video resolution, frame rate, bandwidth and GOP size.

**[Video Signal Type]**

Select the codec type, resolution and frame rate. Choose H.264 or MJPEG for the main stream/sub stream. The supported resolutions are listed below:

<b>Models</b>	<b>Default Codec</b>	<b>Main Stream</b>	<b>Sub Stream</b>
GV-IP LPR Camera 5R GV-LPC1100 GV-LPC1200		MJPEG	H.264
GV-LPR1200 GV-LPC2210 / 2211 / 2011		H.264	H.264

<b>Video Resolution for GV-IP LPR Camera 5R, GV-LPC1100</b>		
Main Stream	4:3	1280 x 960, 640 x 480, 320 x 240
	16:9	1280 x 720, 640 x 360, 448 x 252
	5:4	1280 x 1024, 640 x 512, 320 x 256
Sub Stream	4:3	640 x 480, 320 x 240
	16:9	640 x 360, 448 x 252
	5:4	640 x 512, 320 x 256
<b>Video Resolution for GV-LPC1200 / GV-LPR1200</b>		
Main Stream	16:9	1280 x 720
Sub Stream	16:9	640 x 360
<b>Video Resolution for GV-LPC2210</b>		
Main Stream	4:3	1600 x 1200, 1280 x 960, 640 x 480, 320 x 240
	16:9	1920 x 1080, 1280 x 720, 640 x 360, 448 x 252
	5:4	1280 x 1024, 640 x 512, 320 x 256
Sub Stream	4:3	640 x 480, 320 x 240
	16:9	640 x 360, 448 x 252
	5:4	640 x 512, 320 x 256
<b>Video Resolution for GV-LPC2211 / 2011</b>		
Main Stream	16:9	1920 x 1080, 1280 x 720
Sub Stream	16:9	640 x 360

### [Bandwidth Management]

When using the H.264 codec, it is possible to configure the bitrate settings to control bandwidth usage.

- **VBR (Variable Bitrate):** The quality of the video stream is kept as constant as possible at the cost of a varying bitrate. The bandwidth is much more efficiently used than a comparable CBR. Set the image quality to one of the 5 standards: **Standard, Fair, Good, Great and Excellent.**
- **Maximal Bit Rate:** When the system bitrate exceeds the specified Maximal Bit Rate, the system will automatically lower its bitrate so as not to exceed it. Select one of the bitrates from the drop-down list or select **Auto** if you do not want to enable this function. The default value is 6 MB
- **CBR (Constant Bitrate):** CBR is used to achieve a specific bitrate by varying the quality of the stream. The bitrates available for selection depend on the image resolution.

### [GOP Structure and Length]

Set the maximum number of seconds between every key frame.

**[H264 Video Entropy Coding Setting]** Note this function is only available for **GV-LPC2210**.

By default, the entropy coding is set to CAVLC. To change it to CABAC, click and select from the drop-down list.

### [Text Overlay Settings]

- **Overlaid with camera name:** Includes camera names on live and recorded videos.
- **Overlaid with date stamps:** Includes date stamps on live and recorded videos.
- **Overlaid with time stamps:** Includes time stamps on live and recorded videos.
- **Overlaid with digital input description name:** Includes the name of the selected input on live and recorded videos. Note this function is not available for **GV-IP LPR Camera 5R**.

**[Text Overlay Settings (OSD)]** Note this function is only available for **GV-LPC 2210 / 2211 / 2011**. Displays camera name, date, and/or time on the live view and recorded videos when viewing through GeoVision software and third-party software through ONVIF and RTSP.

- **Name:** Type the camera name.
- **Font Size:** Select the font size using the drop-down list.

- **Overlay with:** Select one or more of the options below to be overlaid on the live view and recorded videos. Use the drop-down list to select the display position.
  - **Camera Name**
  - **Date**
  - **System Time**

### [Watermark Setting]

Enable this option to watermark all recordings. The watermark allows you to verify whether the video has been tampered while it was recorded. Note this function is not available in **GV-LPC2211 / 2011**. See *5.4 Verifying Watermark*.

### [TV Out]

Select the signal format for the video output of the camera as either **NTSC** or **PAL**. This function is disabled by default. Note this function is not available for **GV-IP LPR Camera 5R** and **GV-LPC2211 / 2011**.

---

**Note:** For smooth live view display of **GV-IP LPR Camera 5R / GV-LPC1100** on TV monitor, the video resolution must be of 1280 x 1024 or lower. If dual streams are enabled, the sub stream must be set to 640 x 480.

---

### [LED Control]

- **Ready LED:** Select **Disable** if you do not wish to use the Status LED. Note this function is only available for **GV-LPC1100** and **GV-LPC2210 / 2211 / 2011**.

**[Special View Setting]** Note this function is only available for **GV-LPC2210 / 2211 / 2011**..

- **D/N:** Sets the sensitivity of day-night mode switch. The higher the sensitivity value, the more sensitive the switch is from day mode to night mode. The default value is 5.
  - **Auto:** Select **Auto** for the camera to detect the amount of light present and automatically switch to monochrome in a poorly-lit scene. Move the slider to adjust the sensitivity level from 0 to 10.
  - **Black and White:** Select this option for the live view to be in monochrome.
  - **Color:** Select this option for the live view to be in color.

- ⊙ **Trigger by Input:** This function is only supported by **GV-LPC2210**. Select this option to switch between day mode and night mode once the input device (e.g. sensor or button) is triggered.
- **BLC:** Select **On** to enable Backlight Compensation (BLC). This function is used to adjust the color intensity of scenes with strong light at the background.
- **IR Light:** Select **Auto** for automatic switch between day mode and night mode depending on the amount of light detected. Select **Off** to completely disable IR LEDs.



### 4.1.1.2 Recognition Result

Note the function is only supported by **GV-LPR1200**. This function allows you to display the recognized plate number, the date and time of recognition, or a desired text on the images of the recognition results.

#### Text Overlay

In this section you can set up Text Overlay

Overlay Logo on Recognition Results

Overlay Time on Recognition Results

Overlay LPR Result on Recognition Results

Overlay Text Position

Figure 4-3A



Figure 4-3B

- **Overlay Logo on Recognition Results:** Includes a desired text or description on recognition results.
- **Overlay Time on Recognitions Results:** Includes date stamps on recognition results.
- **Overlay LPR Result on Recognition Results:** Includes the recognized plate number on recognition results.
- **Overlay Text Position:** Select a position from the drop-down list to overlay the text on recognition results.

## 4.1.2 Motion Detection / Detection Mode

### 4.1.2.1 GV-IP LPR Camera 5R / GV-LPC1100 / 1200 / 2210 / 2211 / 2011

Motion detection is used to generate an alarm whenever movement occurs within the scene. You can configure up to 8 detection zones with different sensitivity values. Create at least one detection zone to enable this function.

### Motion Detection

In this section you can define different region(s) for motion detection.

To trigger digital output relay upon motions, be sure to set up the detection area on the Motion Detection page.





Camera

Sensitivity: 9

---

**Motion Detection**

Ignore environmental changes

Noise Tolerance

---

**Advanced Setting**

Please advise which action(s) should be taken when motion detection is activated.

Trigger digital output relay  Output 1

Figure 4-4a GV-IP LPR Camera 5R / GV-LPC1100 / GV-LPC2210

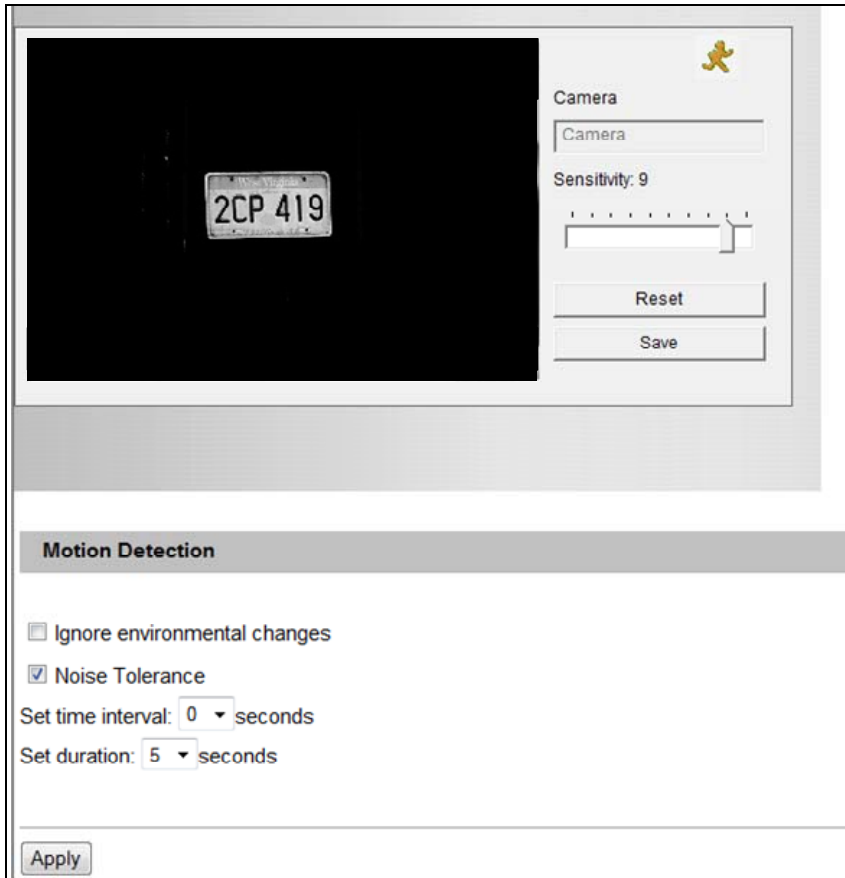

Figure 4-4b GV-LPC2211 / 2011

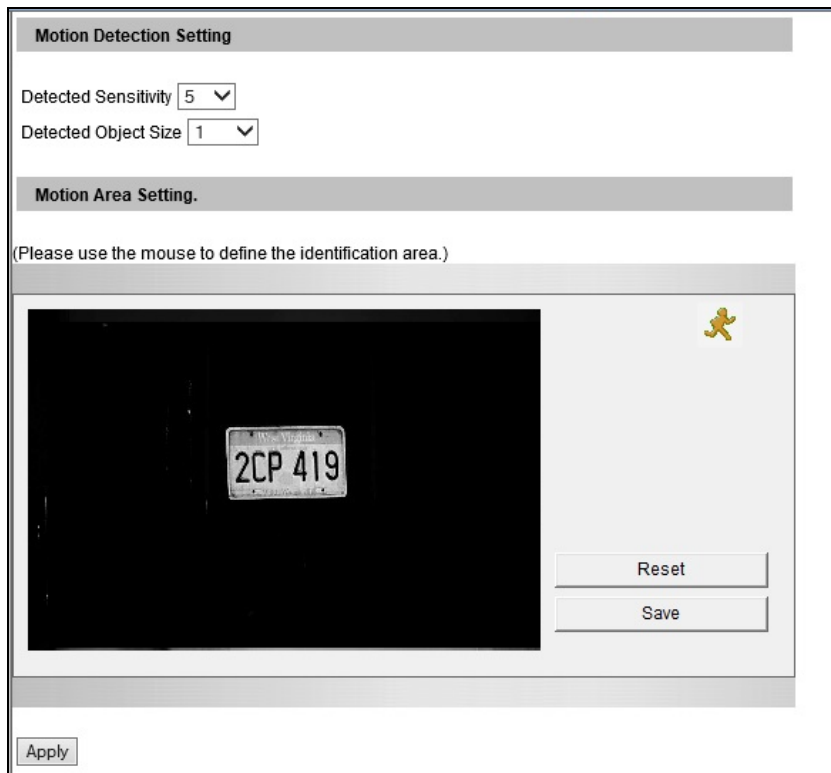

Figure 4-4c GV-LPC1200

1. Select a **Sensitivity** value. There are 10 sensitivity levels. The higher the value, the more sensitive the camera is to motion. The default sensitivity value is **9** for GV-IP LPR Camera 5R and GV-LPC1100 / 2211 / 2011 and **5** for GV-LPC1200.
2. For GV-LPC1200, you can select an **Object Size** to define the normal size of your targeted object. The default value is set to 1. The higher the value, the bigger the object's size is.
3. Define a detection zone by dragging an area on the image. Click **Add** when you are prompted to confirm the setting.
4. To create several areas with different sensitivity values, repeat Steps 1 and 2.
5. Click **Save** to save the above settings, or click **Reset** to clear all the selected areas.
6. For the camera to ignore environmental changes such as rain or snow, select the **Ignore environmental changes**. This option is not available for GV-LPC1200.
7. To reduce video noise when the lighting condition changes, select **Noise Tolerance**. This option is not available for GV-LPC1200.
8. If you want to trigger the alarm output when motion is detected, select **Output 1** and click the **Apply** button. To activate the output settings, you must also start **Input** monitoring manually or by schedule. For related settings, see *4.4 Monitoring*. This option is only available for the camera supporting I/O function.
9. For GV-LPC2211 / 2011, you can select **Set Time Interval** ranging from 1 to 3 seconds to specify the interval between motions in order to trigger an alert or a notification. Also select **Set Duration** ranging from 1 to 5 seconds to specify how long the alarm lasts.
10. Click the **Apply** button.

---

**Note:** The alert and notification of motion detection includes e-mail, FTP and Center V2 and Vital Sign Monitor notification. For details, see *4.3.1 E-Mail*, *4.3.2 FTP*, *4.3.3 Center V2* and *4.3.4 VMS (Vital Sign Monitor)*.

---

### 4.1.2.2 GV-LPR1200

For GV-LPR1200, you can set the detection mode to activate license plate recognition by motion detection or sensor triggers. You can define up to 8 detection areas for motion detection and plate recognition.

**Detection Mode**

Motion(stationary camera) ▼

If the recognition is still repeating, it will notify after  second(0~300)

**Motion Detection Setting**

Output recognition result quickly.(It will increase error rate of recognition system.)

Detected Sensitivity  ▼

Detected Object Size  ▼

**Recognition and Motion Area Setting.**

(Please use the mouse to define the identification area.)





**I/O Mode Setting**

Trigger Input  Input 1  Input 2

Force Export.( Used in I/O Mode)

Capture Frame Number in Each Triggered(1-5)  ▼

Repeat Recognition when Recongnition Failed(0~3)  ▼

Figure 4-5

**[Detection Mode]** From the drop-down list on top left, select a method to activate license plate recognition.

- **Disable:** Deactivate recognition.
- **Motion (Stationary Camera):** Activate recognition by motion detection. Select this mode if your camera is fixed at one place.
- **Motion (Mobile Camera):** Activate recognition by motion detection. Select this option if your camera is not fixed at one place or is installed on a vehicle.
- **Motion (Continuous Recognition):** Activate round-the-clock recognition.
- **Parking (I/O):** This option is designed for parking areas. The recognition is activated by input triggers at the parking area. Select which inputs will trigger recognition in the **I/O Mode Setting** section below.
- **Parking (Motion):** This option is designed for parking areas. The recognition is activated by motion detection at the parking area. Select this option if the parking area is without a gate installed to trigger the recognition.
- **If the recognition is still repeating, it will notify after the specified second:** Select this option to avoid multiple recognition results for the same license plate due to the position of the camera. Specify the duration of a recognition result to be displayed if the next license plate recognized is the same as the previous one.

#### **[Motion Detection Setting]**

- **Output recognition result quickly (It will increase error rate of recognition system):** Select this option if you want to have a faster recognition result at the cost of accuracy. This option is suitable for a large amount of traffic and the frames received will go through a fast recognition process (approximately at the processing rate of 1 frame per second).
- **Detected Sensitivity:** Select the sensitivity level of motion detection from the drop-down list. The default value is set to 5. The higher the value, the more sensitive the system is to the motion.
- **Detected Object Size:** Select the value of the targeted object's normal size. The default value is set to 1. The higher the value, the bigger the object's size is.

**[Recognition and Motion Area Setting]** To configure the area of motion detection and plate recognition, first click **Reset** to clear the default setting. Then drag the mouse button to select an area of the image. You can define up to 8 areas to outline your detection areas. Every time when an area is selected, you will be prompted for confirmation.

Click **Save** to save the defined areas.

#### **[I/O Mode Setting]**

- **Trigger Input:** Select to trigger **Input 1** or **Input 2**.
- **Force Export (Used in I/O Mode):** Select to display the symbol **\*\*\*\*\*** to represent unknown license plates even though the recognition fails. If the option is not selected, the recognition failure will not be recorded.
- **Capture Frame Number in Each Triggered (1~5):** Select the number of image frames from 1 to 5 to be captured when the recognition is activated by input trigger.
- **Repeat Recognition when Recognition Failed (0~3):** Select the number of recognitions from 1 to 3 to be performed after the recognition fails and being activated by input trigger.

Click **Apply** to take effect.

For the related settings of input devices, see *4.2.1 Input Setting*.

### 4.1.3 Privacy Mask

Note the function is only supported by **GV-IP LPR Camera 5R** and **GV-LPC1100 / 2210 / 2211 / 2011**.

The Privacy Mask can block out sensitive areas from view, covering the areas with dark boxes in both live view and recorded clips. This feature is ideal for privacy protection on locations with private information, keyboard sequences (e.g. passwords), and any place you would like to keep inaccessible to view.

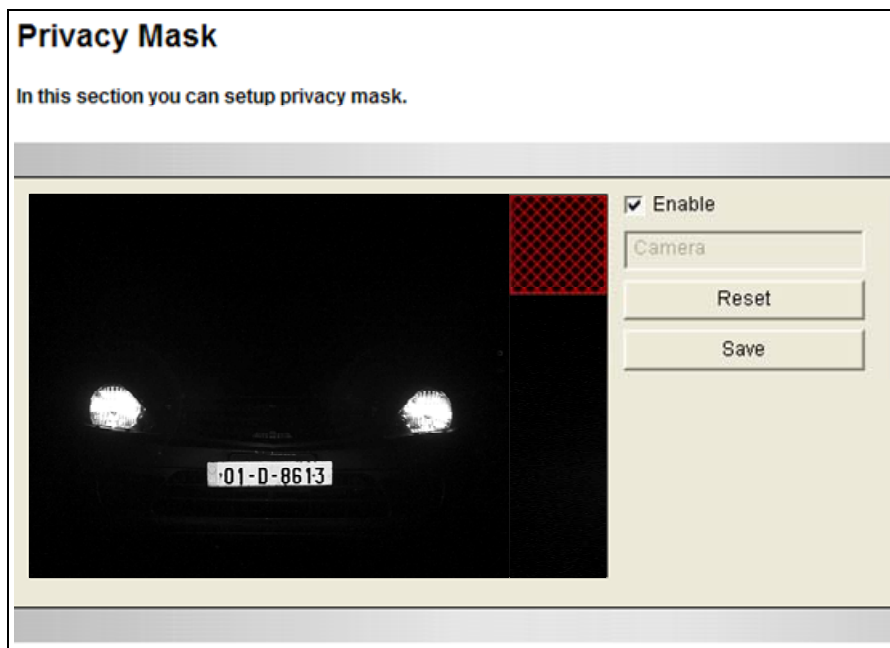

Figure 4-6

1. Select the **Enable** option.
2. Drag the area(s) where you want to block out on the image. Click **Add** when you are prompted to confirm the setting.
3. Click the **Save** button to save all the settings.



### 4.1.4 Text Overlay

The Text Overlay allows you to overlay any text in any place on the camera view. Up to 16 text messages can be created on one camera view. The overlaid text will be saved in the recordings.

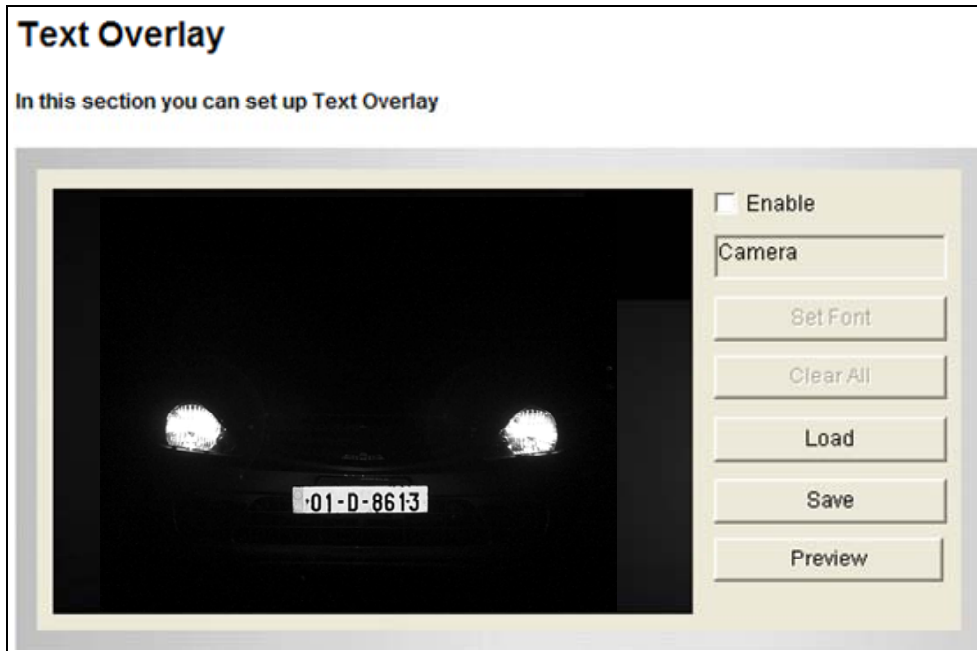

Figure 4-7

1. Select the **Enable** option.
2. Click **Set Font** to set up the font, font style and font size in a pop-up window.
3. Click any place on the image. This dialog box appears.

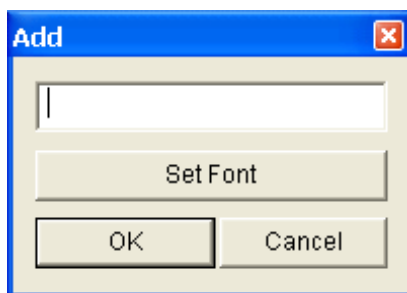

Figure 4-8

4. Type the desired text, and click **OK**. The text is overlaid on the image.
5. Drag the overlaid text to a desired place on the image.
6. Click **Set Font** to modify the font settings.
7. Click **Save** to apply the settings, or click **Load** (Undo) to revert to the last saved setting.
8. Click **Preview** to see how the text will appear on the image. Click **Close** to end the preview.

### 4.1.5 Tampering Alarm

Note the function is only supported by **GV-LPC2210 / 2211 / 2011**. Tampering Alarm is used to detect whether a camera is being physically tampered. An alarm can be generated when the camera is moved, covered up, or out of focus. The alarm types include triggered the output device, e-mail alert and notifying the connected GV-Center V2, GV-Vital Sign Monitor and GV-System / GV-VMS.

To establish the tampering alarm, set up at least one alarm type:

- To trigger the output device when a tampering event occurs, enable the output setting and select **Tampering Alarm**. See *4.2.2 Output Settings*.
- To trigger the e-mail alert when a tampering event occurs, enable the e-mail setting and select **Tampering Alarm**. See *4.3.1 E-Mail*.
- To notify GV-Center V2, GV-Vital Sign Monitor and GV-System / GV-VMS when a tampering event occurs, enable the connection to these systems. See *4.3.3 Center V2*, *4.3.4 Vital Sign Monitor* and, *6.1 Setting up an IP Camera on GV-System*, and *6.2 Setting Up IP Cameras on GV-VMS* respectively.

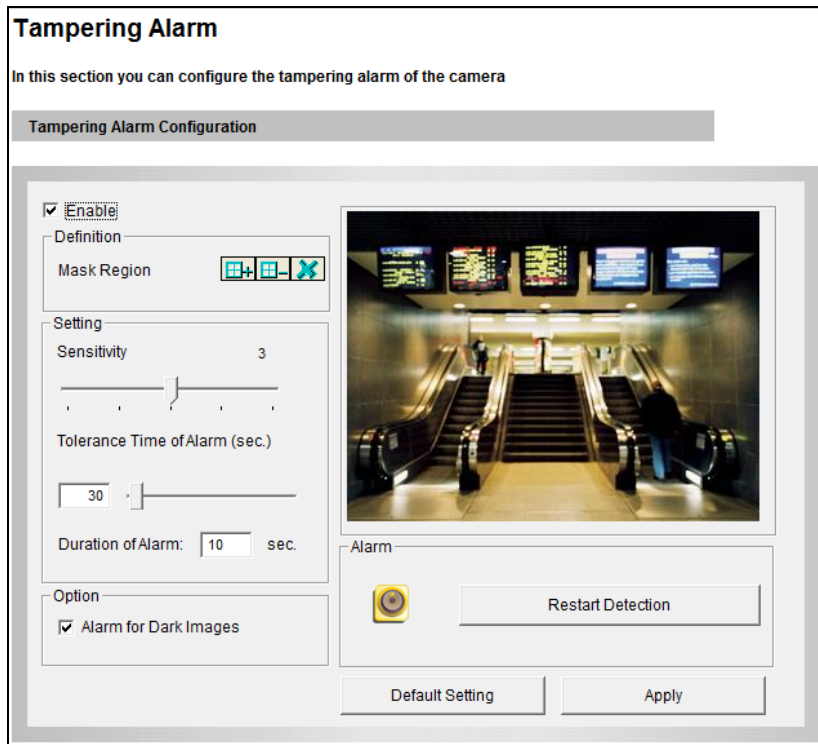



Figure 4-9

To configure the tampering alarm:

1. Select the **Enable** option.
2. If you want the camera to ignore any movement or scene change in certain areas, click the  button to drag areas on the camera view.
3. Select the desired detection sensitivity by moving the slider. The higher the value, the more sensitive the camera is to scene changes.
4. In the **Tolerance Time of Alarm** field, specify the time length allowed for scene changes before an alarm is generated.
5. In the **Duration of Alarm** field, specify the duration of the alarm after which the triggered output device will be turned off.
6. To trigger an alarm when the scene turns dark, e.g. when the lens of camera is covered, make sure the **Alarm for Dark Images** option is enabled. By default, this function is enabled.
7. Click **Apply** to save all the settings.
8. Start monitoring to enable the function. To have output alarm, it is required to start **Input** monitoring. See *4.4 Monitoring*.

When the camera has been tampered, the output device can be activated. To turn off the output device immediately, return to this setting page, and click **Restart Detection**.

## 4.1.6 Visual Automation

Note this function is only supported by cameras with I/O function. This intuitive feature helps you automate any electronic device by triggering the connected output device. When you click on the image of the electronic device, you can simply change its current state, e.g. light ON.

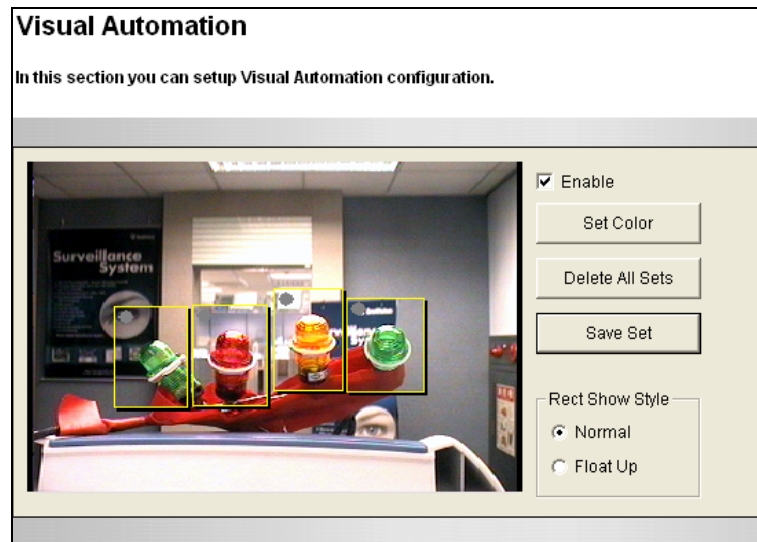

Figure 4-10

1. Select the **Enable** option.
2. Drag an area on the image of the electronic device. This dialog box appears.

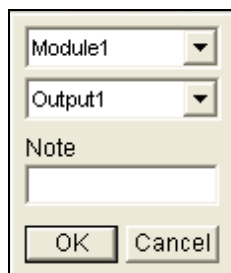

Figure 4-11

3. Assign the connected module and output device. In the Note field, type a note to help you manage the device. Click **OK** to save the settings.
4. To change the frame color of the set area, click the **Set Color** button.
5. To emboss the set area, select **Float Up**; or keep it flat by selecting **Normal**.
6. Click the **Save Set** button to apply the settings.
7. To perform the function, see 3.13 *Visual Automation*.

### 4.1.7 Recognition Engine Settings

Note this function is only available for **GV-LPR1200**. You can adjust the recognition engine to improve the recognition process and increase the accuracy.

#### Recognition Engine Settings

In this section you can set parameters of LPR engine.

Engine Setting

Country GLOBAL ▼

Maximum Number of Characters:(1~16) 9

Minimum Number of Characters:(1~16) 4

(Chinese characters need 2 digits-> CHINA 5~8(6 + 1 chinese))

Maximum Height of Characters:(12~240) 200

Minimum Height of Characters:(12~240) 12

Maximum Numbers of Plate(1~8) 1

---

2 Row Enable  
(Two row recognition will be triggered if numbers of recognized characters are more than numbers of plate in one row.)

Maximum Numbers of Plate in One Row(1~16) 4

Minimum Numbers of Plate in One Row(1~16) 2

---

Fast Slope Detetion Enable  
 Slope Detection Enable

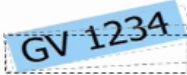

Minimum Slope Angle:(-25~25) -10

Maximum Slope Angle:(-25~25) 10

---

Slant Detection Enable

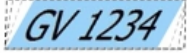

Minimum Slant Angle:(-15~15) -10

Maximum Slant Angle:(-15~15) 10

---

Special Plate Detection Enable  
(Chinese characters need 2 digits-> CHINA 5~8(6 + 1 chinese))

Maximum Number of Special Characters:(1~16) 7

Minimum Number of Special Characters:(1~16) 4

Enable Word Filter

Figure 4-12

#### [Engine Setting]

- **Country:** Select a recognition engine to be set up.
- **Maximum number of characters:** Set the maximum number of characters allowed on the license plate to activate the recognition process. If the number of characters exceeds the limit, the system will not start the recognition.
- **Minimum number of characters:** Set the minimum number of characters allowed on the license plate to activate the recognition process. If the number of characters does not reach the minimum requirement, the system will not start the recognition.

- **Maximum height of characters:** You can set the maximum height of characters on the license plate in pixels to activate the recognition process.
- **Minimum height of characters:** Set the minimum height of characters on the license plate in pixels to activate the recognition process.
- **Maximum number of plates:** Set the maximum number of plates to be recognized simultaneously.
- **Two Row Enable:** This option can recognize two rows of characters on license plates. Note this option is only available on the engine version of V5000 or later.
- **Maximum numbers of plate in one row:** Set the maximum number of characters in one row allowed on the license plate to activate the recognition process. If the number of characters exceeds the limit, the system will not start the recognition.
- **Minimum numbers of plate in one row:** Set the minimum number of characters in one row allowed on the license plate to activate the recognition process. If the number of characters does not reach the minimum requirement, the system will not start the recognition.
- **Fast Slope Detection Enable:** This option can increase the recognition speed by 10 % but decrease the accuracy by 3%.
- **Slope Detection Enable:** The license plate tilting in a horizontal direction can be detected.
  - ⊙ **Minimum angle of slope:** Set the minimum tilt angle to be allowed to activate the recognition process.
  - ⊙ **Maximum angle of slope:** Set the maximum tilt angle to be allowed to activate the recognition process.
- **Slant Detection Enable:** The license plate tilting in a vertical direction can be detected.
  - ⊙ **Minimum angle of slant:** Set the minimum tilt angle to be allowed to activate the recognition process.
  - ⊙ **Maximum angle of slant:** Set the maximum tilt angle to be allowed to activate the recognition process.
- **Special Plate Detection Enable:** This option can recognize Traditional Chinese characters. This option and the following sub options are only available for the Taiwan recognition engine.
  - ⊙ **Maximum number of characters:** Set the maximum number of special characters allowed on the license plate to activate the recognition process. If the number of characters exceeds the limit, the system will not start the recognition.

- ⊙ **Minimum number of characters:** Set the minimum number of special characters allowed on the license plate to activate the recognition process. If the number of characters does not reach the minimum requirement, the system will not start the recognition.
- ⊙ **Enable Word Filter:** Enable the recognition for the character “軍” on license plates of military vehicles. Note this option is only available on the engine of Taiwan.
- ⊙ **Special Enable Moto Enable:** Enable the recognition for motorcycle license plate.
- ⊙ **Alphabet Filter Enable:** Select this option to filter out extraneous alphabetical characters around the license plate and increase recognition accuracy.
- ⊙ **Digit Filter Enable:** Select this option to filter out extraneous numerical characters around the license plate and increase recognition accuracy.

The following options can be enabled to avoid misidentification of certain characters in some countries.

- **I to 1 Enable:** Always identify the character “I” as “1” (one).
- **1 to I Enable:** Always identify the character “1” as “I” (letter I).
- **0 to O Enable:** Always identify the character “0” as “O” (letter O).
- **Q to 0 Enable:** Always identify the character “Q” as “0” (zero). Note this option is only available on the engine version of V5000 or later.
- **Enable Color Inverse:** Enable the recognition for both license plates of “white characters on black background” and “black characters on white background”. By default, this option is enabled. Note this option is only available on the engines of China and Global.
- **Enable Gray Scale Inverse:** Enable the recognition for the license plate of “white characters on black background” only. By default, this option is disabled. Note this option is only available on the engines of China and Global.
- **Enable TC:** This function is only used to recognize the first Simplified Chinese character on China license plates. A China license plate consists of Simplified Chinese characters, English letters and numbers.
  - ⊙ **WeightChar:** Emphasizes the analysis of a Simplified Chinese character, such as the character “沪”.
  - ⊙ **WeightCharRate(0-10):** Defines the rate of occurrence of the weighted character. The higher the rate is defined, the more possible the weighted character will be recognized.
  - ⊙ **AutoChinese:** Adds the weighted character to the recognition result if the camera does not recognize any Simplified Chinese character.

- ⊙ **FixChinese:** Overwrites with the weighted character regardless of whether the first Simplified Chinese character is recognized.

**[Rule Setting]** You can set up recognition rules to increase recognition accuracy. The rule can only consist of letters A and D, and its length must equal that of the license plate number. Use “A” and “D” to represent one alphabetical character and one numerical character of your license plate number respectively. For example, if the license plate is “ABC123” you can type “AAADDD” in one of the Rule fields. Up to 5 rules can be set.

- **(When rule settings are A) 0 to D:** Always identify the letter “O” as letter “D”. This is the default setting. It is useful to avoid misidentification in some countries’ license plates which is hard to distinguish between letter “O” and letter “D”. Select this option to activate a concurrent condition with the rules that you have set. For instance, if the rule entered in the field is “AADDD”, the recognition result will be “AD123” for license plate which appears to be “A0123”
- **(When rule settings are A) 0 to O:** Always identify the letter “O” as letter “O”. Select this option to activate a concurrent condition with the rules that you have set. For instance, if the rule entered in the field is “AAADDA”, the recognition result will be “IBZ02O” for license plate which appears to be “IBZ020”



## 4.2 I/O Control

Note this function is only supported by cameras with I/O function. You can connect your camera to other I/O devices with the I/O wires for extensible connection. Strip the desired wires first, and connect the auxiliary devices with the right wires according to the assignments to the wires in *1.3.5.3 Wire Definition*.

### 4.2.1 Input Settings

To activate the sensor input, select **Enable**.

The screenshot shows the 'Input Setting' configuration page. It contains two sections for 'Digital Input 1' and 'Digital Input 2'. Each section has the following options:

- Enable
- Name: Input1 (for Digital Input 1) / Input2 (for Digital Input 2)
- Normal State:  Open Circuit (N/O)  Grounded Circuit (N/C)
- Latch Mode:  Enable
- Trigger digital output relay:  Output 1  Output 2
- Send Video to CenterV2:  Camera

An 'Apply' button is located at the bottom left of the configuration area.

Figure 4-13

- **Normal State:** You can set the input state to trigger actions by selecting **Open Circuit (N/O)** or **Grounded Circuit (N/C)**.
- **Latch Mode:** Enable this option to have a momentary output alarm.
- **Trigger digital output relay:** When this option is enabled, the output will be triggered once the input is activated.
- **Send Video to Center V2:** Enable this option to send the images to Center V2 when the input is triggered.

**Note:**

1. The cameras with I/O function support dry-contact input devices.
2. The functions “triggering the output”, “Recording starts when the input is triggered” and “sending video to Center V2” only work after you start **Input** monitoring manually or by schedule. To configure the input monitoring, see *4.4 Monitoring*.

## 4.2.2 Output Settings

To start the output device, select **Enable**.

**Note:** Connect a gate or barrier only to output 1.

### Output Setting

In this section you can configure GV-IPCAM digital output port.

#### Digital Output 1 - Normal State

Enable

Name

General Mode  Open Circuit (N/O)  Grounded Circuit (N/C)

Toggle Mode  Open Circuit (N/O)  Grounded Circuit (N/C)

Pulse Mode  Open Circuit (N/O)  Grounded Circuit (N/C)

Trigger Pulse Mode for  seconds(1~60)

#### Digital Output 1 - Alarm Settings

Rec Error

HD Full

#### Digital Output 2 - Normal State

Enable

Name

General Mode  Open Circuit (N/O)  Grounded Circuit (N/C)

Toggle Mode  Open Circuit (N/O)  Grounded Circuit (N/C)

Pulse Mode  Open Circuit (N/O)  Grounded Circuit (N/C)

Trigger Pulse Mode for  seconds(1~60)

#### Digital Output 2 - Alarm Settings

Rec Error

HD Full

<input type="checkbox"/>	Plate Recognized: Registered Vehicle
<input type="checkbox"/>	Plate Recognized: Registered Vehicle(Invalid Schedule)
<input type="checkbox"/>	Plate Recognized: Unregistered Vehicle
<input type="checkbox"/>	Plate Recognized: Unregistered Vehicle(Invalid Schedule)
<input type="checkbox"/>	Parking Access Denied: Gate Disabled
<input type="checkbox"/>	Parking Access Denied: No Entry
<input type="checkbox"/>	Parking Access Denied: Full
<input type="checkbox"/>	Parking Access Denied: Re-entry
<input type="checkbox"/>	Parking Access Denied: No entry record
<input type="checkbox"/>	Parking Access Denied: Share Space Full
<input type="checkbox"/>	Keyword
<input type="checkbox"/>	Hotlist
<input type="button" value="Apply"/>	

Figure 4-14

- **General Mode:** Choose the output signal that mostly suits the device you are using: **Open Circuit (N/O)**, **Grounded Circuit (N/C)**.
- **Toggle Mode:** The output continues to be triggered until a new input trigger ends the output.
- **Pulse Mode:** The output is triggered for the amount of time you specify in the **Trigger Pulse Mode for x Seconds** field.

**[Alarm Settings]** Only for **GV-LPR1200**, you can choose to automatically trigger the digital output under the selected conditions, which can be categorized under the below events.

- **Memory Card related events:** Rec Error / HD Full
- **Plate Recognition related events (Output 2 only):** Unregistered / Registered Vehicle (Invalid Schedule) / Keyword / Hotlist
- **Parking Lot related events (Output 2 only):** Gate Disabled / No Entry / Full / Re-entry / No Entry Record / Share Space Full

---

**Note:**

1. The **Alarm Settings** only work when the database of GV-LPR1200 is connected by GV-ASManager V4.4 or later. See [4.3.10 Registry Database](#) to configure the settings.
  2. The **Parking Lot related functions** only work when the parking lot function is enabled on GV-ASManager V4.4 or later. See [13.8 Managing Parking Lots on GV-ASManager User's Manual](#).
-

### 4.2.3 RS485

Note this function is only supported by **GV-LPR1200**. To export recognition data through RS-485, select **Enable**. GV-LPR1200 uses a baud rate of 9600.

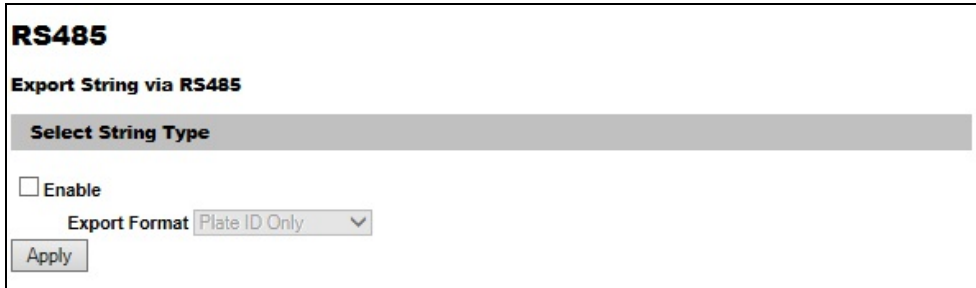

**RS485**

Export String via RS485

Select String Type

Enable

Export Format Plate ID Only

Apply

Figure 4-15

#### [Select String Type]

- **Export Format:** Select the desired recognition results from the drop-down list to export, including Plate Only, Plate ID and Time, and Plate File Name.

## 4.3 Events & Alerts

For motion and alarm events, the Administrator can set up two types of alert:

1. Send a captured image by e-mail or FTP. See *4.3.1 E-Mail* and *4.3.2 FTP*.
2. Notify Center Monitoring Stations such as Center V2, VSM (Vital Sign Monitor), by video or text alerts.

To enable above alerts, you must also set the following features:

- Motion Detection (See *4.1.2 Motion Detection / Detection Mode*)
- For e-mail and FTP alerts, it is required to start monitoring (See *4.4 Monitoring*).

### 4.3.1 E-mail

When a motion is detected, the camera can send an e-mail alert, containing a captured image to a remote user.

---

**Important:** To send e-mail alert upon motion, make sure you also enable the Motion Detection / Detection Mode function. For setup details, see [4.1.2 Motion Detection / Detection Mode](#).

---

**Email**

In this section you can configure mailserver (SMTP) to handle events, videos, and error messages.

To notify the E-mail Server upon motions, be sure to set up the detection area on the Motion Detection page.

**Primary mail server**

Enable

Server URL/IP Address

Server Port

From email address

Send to   
(Please use "," to separate recipients' addresses)

Alerts Interval time in minute (0 to 60)

Need authentication to login

User Name

Password

This server requires a secure connection (SSL)

**Email - Alarm Settings**

Rec Error

HD Full

Motion Detection

Digital Input

Figure 4-16

To enable the e-mail functions:

1. Select **Enable** to set up e-mail notifications.
2. **Server URL/IP Address:** Type the SMTP Server's URL address or IP address.
3. **Server Port:** Type the SMTP Server's port number or keep the default value **25**.
4. **From email address:** Type the sender's e-mail address.
5. **Send to:** Type the e-mail address(s) you want to send alerts to.

6. **Alerts interval time in minute:** Specify the interval between e-mail alerts. The valid interval is from 0 to 60 minutes. This option is useful for frequent event occurrence. Any event detected during the interval period will be ignored.
7. If the SMTP Server needs authentication, select **Need authentication to login** and type a valid **Username** and **Password** to log in the SMTP server. If the SMTP Server needs a secure connection (SSL), select **This server requires a secure connection**.
8. **Email-Alarm Settings:** Select an event to automatically send an e-mail alert.
  - **Tampering Alarm:** Sends an e-mail alert when a tampering event occurs. This function is only supported by **GV-LPC2210 / 2211 / 2011**.
  - **Rec Error:** Sends an e-mail alert upon a memory card writing error. This function is only supported by **GV-LPR1200**.
  - **HD Full:** Sends an e-mail alert when the memory card is full. This function is only supported by **GV-LPR1200**.
  - **Motion Detection:** Sends an e-mail alert when the camera detects a motion.
  - **Digital Input:** Sends an e-mail alert upon a triggered input event. Note this function is only supported by cameras with I/O function.
9. Click **Apply**.
10. In the left menu, select **Monitoring** and click the **Start** button to start monitoring.

### 4.3.2 FTP

You can also send the captured image to a remote FTP server for alerts.

---

**Important:** To send FTP alert upon motions, be sure to set up the detection area on the Motion Detection page. For details, see [4.1.2 Motion Detection / Detection Mode](#).

---

#### FTP Client and Server Setting

In this section you can configure an ftp server (File Transfer Protocol) to handle events, videos, and error messages.

To notify the FTP Server upon motions, be sure to set up the detection area on the Motion Detection page.

**Upload to an FTP server**

Enable

Passive Mode  Active Mode

Server URL/IP Address

Server Port

User Name

Password

Remote Directory

Alerts Interval time in minute (0 to 60)

#### FTP - Alarm Settings

Motion Detection

Continuously send images upon trigger events(Motion)

Digital Input

Continuously send images upon trigger events (Input)

Continuously send images

Interval

Enable recycling, Keep days (1-255)

Figure 4-17

#### [Upload to a FTP server]

1. Select **Enable** to set up the FTP function.
2. Select **Active Mode** or **Passive Mode**, depending on the setting of your FTP server. Note this function is only supported by **GV-LPC2210 / 2211 / 2011**.
3. **Server URL/IP Address:** Type the URL address or IP address of the FTP Server.
4. **Server Port:** Type the port number of the FTP Server or keep the default value **21**.
5. Type the **Username** and **Password** of the FTP Server.
6. **Remote Directory:** Type the name of the storage folder on the FTP Server.



7. **Alerts interval time in minute:** Specify the interval between FTP alerts. The interval can be between 0 and 60 minutes. The option is useful for frequent event occurrence. Any event triggers during the interval period will be ignored.
8. **FTP-Alarm Settings:**
  - **Motion Detection:** Select to automatically send a snapshot to the FTP Server upon motion detection. Select **Continuously send images upon trigger events (Motion)** to upload a series of snapshots to the FTP Server upon motion detection.
  - **Digital Input:** Note this function is only supported by cameras with I/O function. Select to automatically send a snapshot to the FTP Server when a digital input is triggered. Select **Continuously send images upon trigger events (Input)** to upload a series of snapshots to the FTP Server upon input trigger events.
  - **Continuously Send Images:** Note this function is only supported by **GV-LPC2210 / 2211 / 2011**. Sends images to the FTP server at the specified interval.
    - ⊙ **Interval:** Use the drop-down list to specify how frequent the images are sent to the FTP server.
    - ⊙ **Enable Recycling:** Select this option to recycle the FTP storage at the specified Keep Day.
    - ⊙ **Keep Days:** Specify how frequent the images saved at the FTP server are recycled. By default, the Keep Day is set to **1**.
9. In the left menu, select **Monitoring** and click the **Start** button to start monitoring.

**[Act as FTP server]** The function is only supported by **GV-LPR1200**.

1. **Enable FTP access to the GV-IP Cam:** Select to allow the camera to act as an FTP server for users to download AVI files.
2. **Use alternative port:** The default port is set to 21.

### 4.3.3 Center V2

The central monitoring station Center V2 can be notified of a motion event by live videos and text alerts. Up to **two** Center V2 servers can be connected. For live monitoring through Center V2, you must already have a subscriber account on each of the Center V2 server.

---

**Important:** To notify the Center V2 Server upon motion events, be sure to set up the detection area on the Motion Detection page. For details, see [4.1.2 Motion Detection / Detection Mode](#) and [7.1 Center V2](#).

---

Connection1
Connection2

## Center V2

In this section you can configure the connection to Center V2 and tasks to perform.

To notify the Center V2 Server upon motions, be sure to set up the detection area on the Motion Detection page.

Center V2 server

Activate Link

Host name or IP Address:

Port number:

User Name:

Password:

Cease motion detection messages from  Camera

Enable schedule mode

Select schedule time

Span 1   ~   Next Day

Span 2   ~   Next Day

Span 3   ~   Next Day

Weekend  Saturday and Sunday  Only Sunday

Connection Status

Status: Connected. Connected Time: Mon Aug 27 13:55:53 2012

Figure 4-18

To enable the Center V2 connection:

1. **Activate Link:** Enable the monitoring through Center V2.
2. **Host Name or IP Address:** Type the host name or IP address of Center V2.
3. **Port Number:** Match the port to **Port 2** on Center V2. Or keep the default value **5551**. For details, see *7.1 Center V2*.
4. **User Name:** Type a valid user name to log in to Center V2.
5. **Password:** Type a valid password to log in to Center V2.
6. Click **Apply**. The Connection Status should display “Connected” and connected time.
7. To establish connection to the second Center V2, click the **Connection 2** tab and repeat the above steps for setup.

You can also find on this Center V2 settings page:

- **Cease motion detection messages from:** Stops notifying Center V2 of motion detection.
- **Enable schedule mode:** Starts the monitoring through Center V2 based on the schedule you set in the **Select Schedule Time** section.

#### [Select schedule time]

- **Span 1- Span 3:** Enable recording (upon motion events) at up to 3 different time frames for a day, represented by Span 1 to Span 3.
- **Weekend:** Enable recording (upon motion events) for both Saturday and Sunday or for Sunday only.

### 4.3.4 VSM (Vital Sign Monitor)

The central monitoring station VSM can be notified of a motion event by text alerts. Up to **two** Vital Sign Monitor servers can be connected. For live monitoring through VSM, you must already have a subscriber account on each of the VSM server.

---

**IMPORTANT:** To notify the Vital Sign Monitor upon motions, be sure to set up the detection area on the Motion Detection page. For details, see [4.1.2 Motion Detection / Detection Mode](#) and [7.2 Vital Sign Monitor](#).

---

Connection1
Connection2

## Vital Sign Monitor Server Setting

In this section you can configure the connection to VSM Server and tasks to perform.

To notify the VSM upon motions, be sure to set up the detection area on the Motion Detection page.

**Vital Sign Monitor Server**

Activate Link

Host name or IP Address:

Port number:

User Name:

Password:

Cease motion detection messages from  Camera

Enable schedule mode

**Select schedule time**

Span 1  :  :  :  Next Day

Span 2  :  :  :  Next Day

Span 3  :  :  :  Next Day

Weekend  Saturday and Sunday  Only Sunday

**Connection Status**

Status: Disconnected

Figure 4-19

To enable the VSM connection:

1. **Activate Link:** Enable the monitoring through VSM.
2. **Host Name or IP Address:** Type the host name or IP address of VSM.
3. **Port Number:** Match the port to **Port 2** on VSM or keep the default value **5609**. For details, see *7.2 Vital Sign Monitor*.
4. **User Name:** Type a valid user name to log into VSM.
5. **Password:** Type a valid password to log into VSM.
6. Click **Apply**. The Connection Status should display “Connected” and connected time.
7. To establish connection to the second VSM, click the **Connection 2** tab and repeat the above steps for setup.

These options you can also find on this VSM setting page:

- **Cease motion detection messages from:** Stops notifying VSM of motion detection.
- **Enable schedule mode:** Starts the monitoring through VSM based on the schedule you set in the **Select Schedule Time** section. For schedule setup, refer to *4.3.3 Center V2*.

### 4.3.5 GV-Video Gateway / GV-Recording Server

The GV-Video Gateway and GV-Recording Server are video streaming servers designed for large-scale video surveillance deployments. The GV-Video Gateway / GV-Recording Server (with recording capability) can receive up to 128 channels from various IP video devices, and distribute up to 300 channels to its clients. With the GV-Video Gateway / GV-Recording Server, the desired frame rate can be ensured while the CPU loading and bandwidth usage of the IP video devices are significantly reduced.

The camera can be connected with up to two GV-Video Gateway / GV-Recording Server. To send the video images to the GV-Video Gateway or GV-Recording Server, you must already have an account on each of the GV-Video Gateway / GV-Recording Server with the user name and password specified below.

Connection 1
Connection 2

#### Video Gateway / Recording Server

In this section you can configure the connection to Video Gateway / Recording Server.

To notify the Video Gateway/Recording Server upon motions, be sure to set up the detection area on the Motion Detection page.

Video Gateway / Recording Server

Activate Link

Host name or IP Address:

Port number:

User Name:

Password:

Enable schedule mode

Select schedule time

Span 1  :  :  :  Next Day

Span 2  :  :  :  Next Day

Span 3  :  :  :  Next Day

Weekend  Saturday and Sunday  Only Sunday

Connection Status

Status: Disconnected

Figure 4-20

To enable connection to GV-Video Gateway / GV-Recording Server:

1. **Activate Link:** Enable the monitoring through GV-Video Gateway / GV-Recording Server.
2. **Host Name or IP Address:** Type the host name or IP address of the GV-Video Gateway / GV-Recording Server.
3. **Port Number:** Match the communication port specified on GV-Video Gateway / GV-Recording Server. Or keep the default value **50000**.
4. **User Name:** Type a valid user name to log into GV-Video Gateway / GV-Recording Server.
5. **Password:** Type a valid password to log into GV-Video Gateway / GV-Recording Server.
6. Click **Apply**. The Connection Status should display “Connected” and connected time.
7. To establish connection to the second GV-Video Gateway / GV-Recording Server, click the **Connection 2** tab and repeat the above steps for setup.

You can also find the option:

- **Enable schedule mode:** Starts the monitoring through GV-Video Gateway / GV-Recording Server based on the schedule you set in the **Select Schedule Time** section. For schedule setup, refer to *4.3.3 Center V2*.

### 4.3.6 RTSP

The RTSP Server enables video and audio streaming to your 3G-enabled mobile phone.

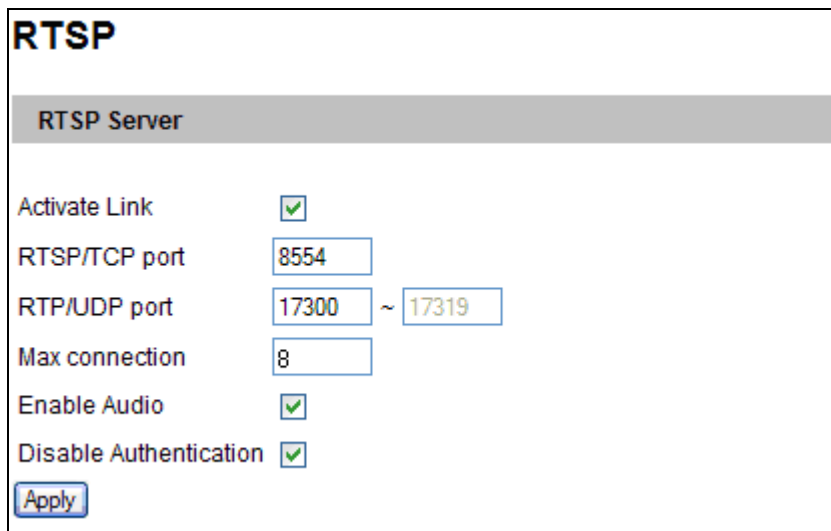

Figure 4-21

- **Activate Link:** Enable the RTSP / 3GPP service.
- **RTSP/TCP Port:** Keep the default value **8554**, or modify it if necessary.
- **RTP/UDP Port:** Keep the default range from **17300** to **17319**, or modify it if necessary. The number of ports for use is limited to 20.
- **Max Connection:** Set the maximum number of RTSP and 3GPP connections to your camera. The maximum value is **8**.
- **Enable Audio:** This option is enabled by default. Select to enable audio streaming through RTSP. Note this function is not available for **GV-IP LPR Camera 5R** and **GV-LPC2211 / 2011**.
- **Disable Authentication:** Authentication is disabled by default, with which the ID and password of your camera are not required when accessing live view through the RTSP command.

For details on remote monitoring with mobile phones, see *Smart Device Connection*, Chapter 8. For RTSP command, see *Appendix B RTSP Protocol Support*.



### 4.3.7 ONVIF

Note this function is only supported by **GV-LPC1200**, **GV-LPR1200** and **GV-LPC2210 / 2211 / 2011**.

Configure the ONVIF settings for a third-party DVR.

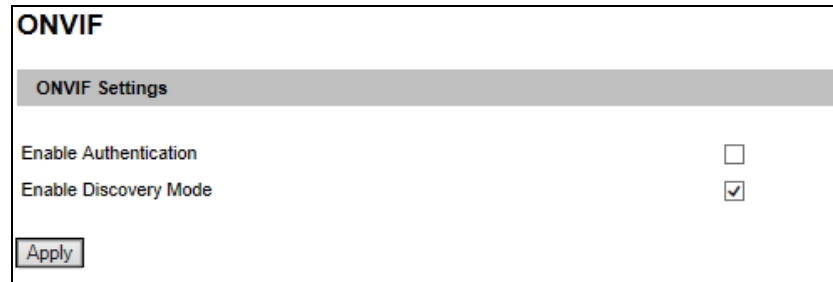

ONVIF Settings	
Enable Authentication	<input type="checkbox"/>
Enable Discovery Mode	<input checked="" type="checkbox"/>
<input type="button" value="Apply"/>	

Figure 4-22

- **Enable Authentication:** The ID and password of the camera are required to access the camera by a third-party DVR through ONVIF.
- **Enable Discovery Mode:** Allows the third-party DVR to browse this camera. This function is enabled by default.

### 4.3.8 POS

Note this function is only available for **GV-LPR1200**.

When the alarm events of motion detection and sensor trigger occur, the GV-System can get alerts with recognized license plate overlaid on the live images. This application is illustrated below.

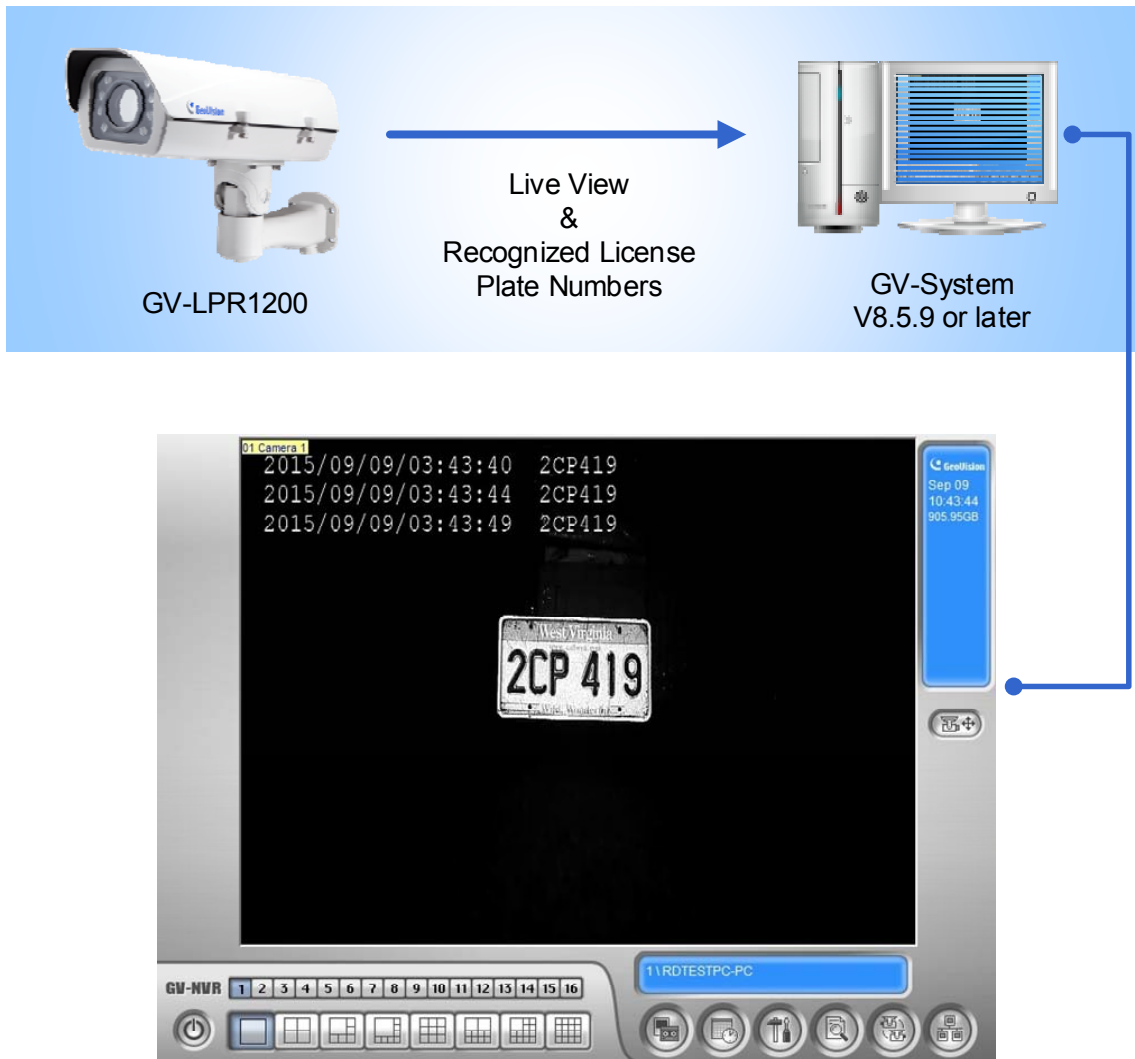

Figure 4-23

---

**Note:** This application is only supported by GV-System V8.5.9 or later.

---

The screenshot shows a web-based configuration interface for POS settings. At the top, the word "POS" is displayed in a large, bold font. Below it, a section titled "Connection Port Settings:" is highlighted with a grey background. This section contains three input fields: "POS Port number:" with the value "4000", "POS ACK Port number:" with the value "3999", and "POS Overlay Plate and Time:" with a dropdown menu currently set to "Plate ID and Time". A small "Apply" button is located at the bottom left of the settings area.

Figure 4-24

**[Connection Port Settings]** Both of **POS Port** and **POS ACK Port** are used for transmitting recognition results to GV-System. The default port numbers are **4000** and **3999** respectively.

- **POS Overlay Plate and Time:** Select whether the recognition results will contain Plate ID and Time or only Plate ID when they are transmitted to GV-System.

The GV-LPR1200 will be added to GV-System through the POS device settings. To set up the GV-LPR1200 on GV-System, see *7.3 POS Device Setup, GV-DVR User's Manual* on GV-NVR Software DVD.

### 4.3.9 Inquire Recognized Database

Note this function is only available for **GV-LPR1200**.

You can enquire the history of a plate number from the database stored in a memory card.

---

**Note:** Make sure you have inserted a memory card that contains the database of recognized license plate numbers.

---

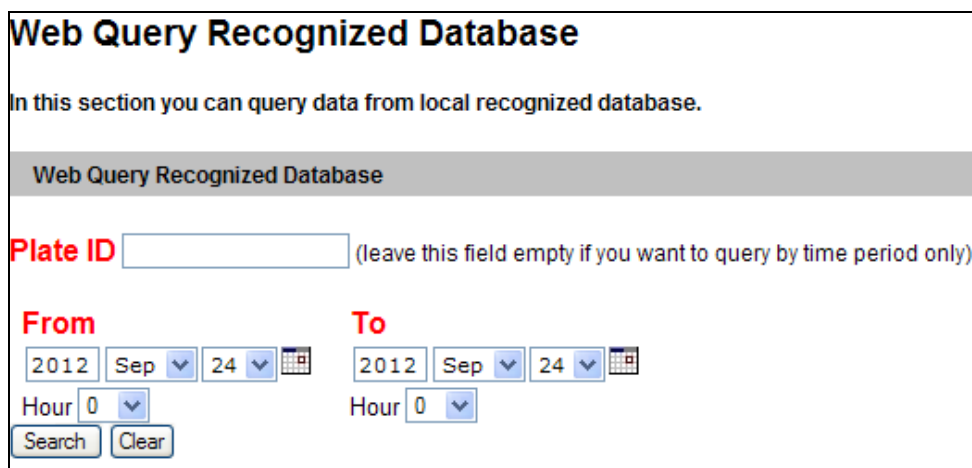

Figure 4-25

1. Type a car plate number in the Plate ID field. The entries are case-sensitive.
2. Specify a start time and an end time by typing the year and using the drop-down lists.
3. Click the **Search** button to start matching.

---

**Tip:** To list all the license plates captured during a period, leave the **Plate ID** field blank and specify the time period.

---

### 4.3.10 Registry Database

Note this function is only available for **GV-LPR1200**.

You can automatically activate an output, for example, opening a gate when a captured license plate matches a number from a database based on the matching criterion.

You can create a standalone database on GV-LPR1200 or obtain the database from GV-ASManager, the software of license plate recognition and access control.

For the integration of GV-ASManager and GV-LPR1200, the vehicle database is transmitted from GV-ASManager and saved on the memory card. To set up the connection with the GV-ASManager for database download, see *GV-ASManager Connection*, Chapter 9.

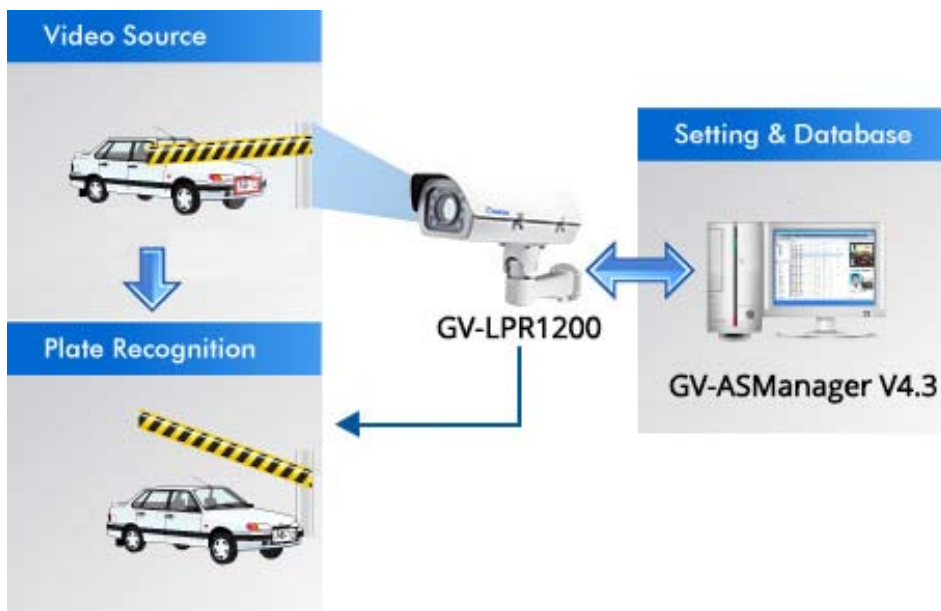

Figure 4-26

To access the database from GV-ASManager:

- Make sure a memory card is inserted to the camera and the storage settings are configured. For detail, see *4.7.2 Storage Settings*.
- Make sure the camera is connected with GV-ASManager to download the vehicle database, or the inserted memory card already contains the vehicle database.
- Make sure the output settings of the gate or barrier are configured and enabled. The gate or barrier must be connected to **output 1** of GV-LPR1200. For detail, see *4.2.2 Output Settings*.

---

**Note:** This function is only supported for GV-ASManager V4.3 or later.

---

### Registry Database Setting

Registry Database

In this section you can set registry database and compared mode.

Enable Registry Database (SD storage is necessary)

Database Control by Standalone ▾

Registry Database Comparison Complete (All Characters Match) ▾

Apply

Standalone Database( Support White List only)

Plate Number FYD1122

Add
Query
Query All
Delete
Delete All

Plate No.	Create Time	
FYD1122	2016-06-06 11:04:22	<span style="border: 1px solid gray; padding: 2px;">Delete</span>

*Figure 4-26*

#### [Registry Database]

1. Select **Enable Registry Database**.
2. Select a type of database for **Database Control** to specify the source of database.
  - **AS Manager:** Select to allow the vehicle database transmitted from GV-ASManager and saved on the memory card. To set up the connection with the GV-ASManager for database download, see *GV-ASManager Connection, Chapter 9*.
  - **Standalone:** Select to activate the function of **Standalone Database**. You can manually register license plates on GV-LPR1200. See *Standalone Database, Support White List only* below.

---

**Note:** When you activate **Standalone Database**, do not connect the camera to GV-ASManager.

---

3. Select one comparison type for **Registry Database Comparison** using the drop-down list. The detected license plate will trigger the output under the selected condition:
  - **Complete (All Characters Match):** The detected license plate matches every character of a license plate in database.
  - **Like (One Character Mismatch):** The detected license plate matches all except one character of a license plate in the database. The first and last characters of that license plate must remain unchanged.
  - **Somewhat Like (Two Characters Mismatch):** The detected license plate matches all except two characters of a license plate in the database. The first and last characters of that license plate must remain unchanged.
4. Click **Apply**.

#### **[Standalone Database, Support White List only]**

You have to select **Standalone Database** to activate this function.

- **Plate Number:** Type license plates and click **Add** to create your database. Click **Query/Query All** to search certain/all license plates. Click **Delete/Delete All** to remove certain/all license plates.

To set the Recognition Engine, recognition conditions, and recognition sensitivity for example, see *4.1.2 Motion Detection / Detection Mode* and *4.1.6 Recognition Engine Settings*.

To open a gate when the detected license plate is recognized as a registered vehicle, see *4.2.2 Output Settings* to see how to set a gate as the output device.

## 4.4 Monitoring

Configure the monitoring settings for your camera.

### 4.4.1 Monitoring Settings

This function is not available for **GV-IP LPR Camera 5R**.

**For GV-LPR1200 and GV-LPC1100 / 1200 / 2210**, you can start monitoring manually, by schedule or by input trigger.

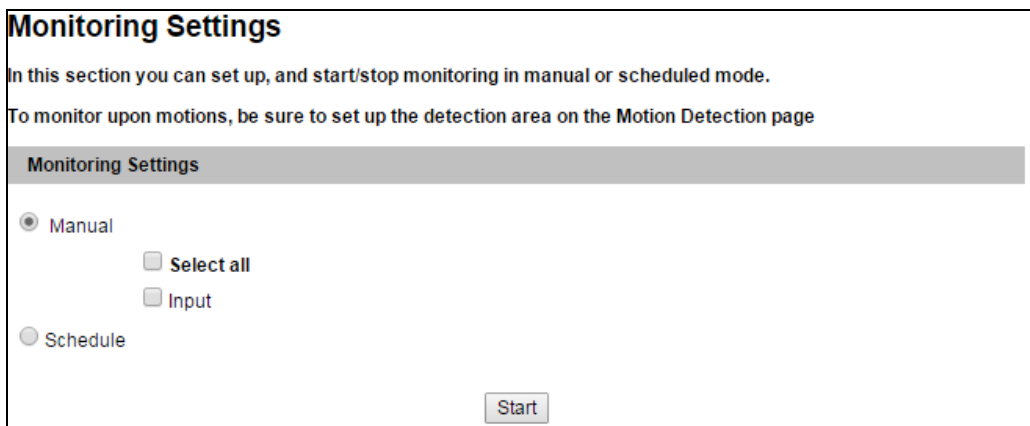

**Monitoring Settings**

In this section you can set up, and start/stop monitoring in manual or scheduled mode.

To monitor upon motions, be sure to set up the detection area on the Motion Detection page

**Monitoring Settings**

Manual

Select all

Input

Schedule

Start

Figure 4-28-a

**[Manual]** Manually activates motion detection and I/O monitoring. Select one of the following options and click the **Start** button.

- **Select all:** Manually starts both motion detection and I/O monitoring. Note this function is not supported by **GV-LPC2210**.
- **Input:** Note this function is only supported for cameras with I/O function. Manually starts I/O monitoring. When the sensor input is triggered, its associated camera and output will be activated for recording and alerting.

**[Schedule]** The system starts motion detection and I/O monitoring according to the schedule you have set.



For **GV-LPC2211 / 2011**, start e-mail and FTP alert functions. Be sure to complete related settings on the **Motion Detection**, **E-mail** and **FTP** pages.

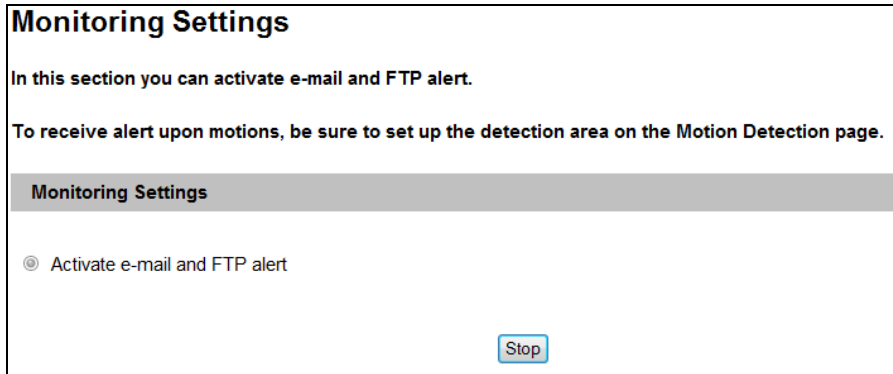

Figure 4-28-b

## 4.5 Schedule

Note this function is only supported by cameras with I/O function. The schedule is provided to activate I/O monitoring on a specific time each day.

### 4.5.1 I/O Monitoring Settings

You can set the schedule for I/O monitoring.

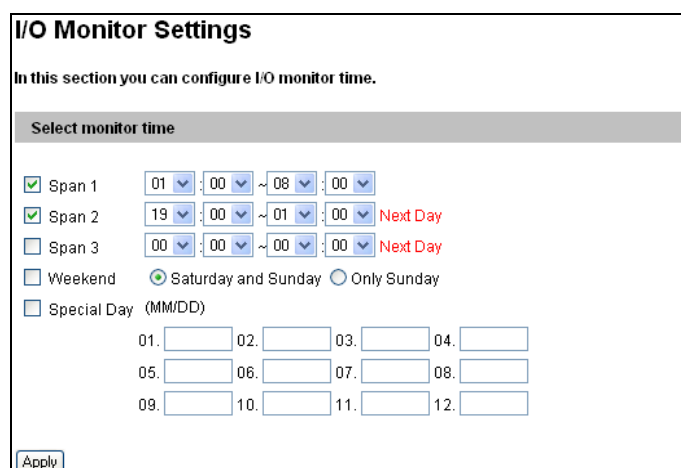

Figure 4-29

- **Span 1- Span 3:** Set different time frames during the day to enable I/O monitoring. Each day can be divided into 3 time frames, represented by Span 1 to Span 3.
- **Weekend:** Enable this option to start I/O monitoring all day on the weekend and define whether your weekend includes **Saturday and Sunday** or **Only Sunday**.
- **Special Day:** Enable I/O monitoring on a specified day.

## 4.5.2 Recognizing Schedule Settings

Note this function is only available for **GV-LPR1200**. You can set the schedule for recognizing license plates.

**Recognizing Schedule Settings**

In this section you can configure schedule time.

Select schedule time

Span 1 Motion(stationary camera) 00:00 ~ 00:00 Next Day

Span 2 Motion(stationary camera) 00:00 ~ 00:00 Next Day

Span 3 Motion(stationary camera) 00:00 ~ 00:00 Next Day

Weekend Motion(stationary camera)  Saturday and Sunday  Only Sunday

Special Day Motion(stationary camera) (MM/DD)

01. [ ] 02. [ ] 03. [ ] 04. [ ]

05. [ ] 06. [ ] 07. [ ] 08. [ ]

09. [ ] 10. [ ] 11. [ ] 12. [ ]

Apply

Figure 4-30

Select a method for license plate recognition from the drop-down list on top left and set different time frames during the day to enable I/O monitoring.

- **Span 1- Span 3:** Set a different recognition mode for each time frame during the day. Each day can be divided into 3 time frames, represented by Span 1 to Span 3. The time frame settings will work from Monday through Sunday.
- **Weekend:** Enable this option to have a whole-day recognition on the weekend and select a recognition mode to be used. Define whether your weekend includes **Saturday and Sunday** or **Only Sunday**.
- **Special Day:** Set the recognition mode on a specified day.

---

**Note:** If the settings for Special Day conflict with those for Span 1-3 or Weekend, the Special Day settings will get priority.

---

### 4.5.3 WDR Settings

Note this function is only available for **GV-LPR / LPC1200**. You can set a schedule of Wide Dynamic Range (WDR) for your camera to generate clear live view when the scene contains very bright and very dark areas.

#### WDR Schedule

In this section you can configure schedule time.

Select schedule time

<input checked="" type="checkbox"/>	Span 1	High	01	00	05	00	
<input type="checkbox"/>	Span 2	Off	00	00	00	00	Next Day
<input type="checkbox"/>	Span 3	Off	00	00	00	00	Next Day

Figure 4-31

- Span 1- Span 3:** Select **Low**, **Middle**, or **High** to set a different image adjustment, or select **Off** to disable the WDR function for each time frame during the day. Each day can be divided into 3 time frames, represented by Span 1 to Span 3. The time frame settings will work from Monday through Sunday.

## 4.6 Network

The Network section includes some basic but important network configurations that enable your camera to be connected to a TCP/IP network.

### 4.6.1 LAN Configuration

According to your network environment, select among Static IP, DHCP and PPPoE.

**LAN Configuration**

In this section you can configure GV-IPCAM to work inside of LAN.

**LAN Configuration**

Dynamic IP address Select this option to obtain IP address from a DHCP server

Static IP address Select this option to enter a Static IP address manually

IP Address:

Subnet Mask:

Router/Gateway:

Primary DNS:

Secondary DNS:  (Optional)

PPPoE Select this option to establish a DSL connection

Username:

Password:

Figure 4-32

#### [LAN Configuration]

- **Dynamic IP address:** The network environment has a DHCP server which will automatically assign a dynamic IP address to the camera. Click the **Test DHCP** button to see the currently assigned IP address or look up the address using GV-IP Device Utility.
- **Static IP address:** Assign a static IP or fixed IP to the camera. Type the camera's IP address, Subnet Mask, Router/Gateway, Primary DNS server and Secondary DNS server.

Parameters	Default
IP address	192.168.0.10
Subnet Mask	255.255.255.0
Router/Gateway	192.168.0.1
Primary DNS server	192.168.0.1
Secondary DNS server	192.168.0.2

- **PPPoE:** The network environment is xDSL connection. Type the Username and Password provided by ISP to establish the connection. If you use the xDSL connection with dynamic IP addresses, first use the DDNS function to obtain a domain name linking to the camera's changing IP address.

For details on Dynamic DNS Server Settings, see *4.6.2 Advanced TCP/IP*.

## 4.6.2 Advanced TCP/IP

This section introduces the advanced TCP/IP settings, including DDNS Server, HTTP port, streaming port and UPnP.

### Advanced TCP/IP

In this section you can set the advanced TCP/IP configuration

---

#### Dynamic DNS Server Settings

In this section you can configure your GV-IPCAM to obtain a domain name by using a dynamic IP.

Enable

Service Provider: Geovision DDNS Server ex: [Register Geovision DDNS Server](#)

Host Name:

User Name:

Password:

Update Time : Mon Jul 18:37:06 GMT8:00 2013 [Refresh](#)

---

#### HTTP Port Settings

In this section you can change the default HTTP port number (80) to any port within the range 1024-65535. It is a simple method to increase system security using port mapping. You can configure HTTP connection to an alternative port.

HTTP Port:

---

#### HTTPS Settings

In this section you can change the default HTTPS port number (443) to any port within the range 1024-65535. It is a simple method to increase system security using port mapping. You can configure HTTPS connection to an alternative port.

Enable

HTTP Port:

Use customized certification and private key. External storage is necessary.

Certificate File:

Certificate Key File:

Password:

Figure 4-33A

**GV-IPCAM Streaming Port Settings**

In this section you can configure Streaming connection from a determine port. The default setting is 10000.

VSS Port

---

**UPnP Settings**

In this section you can enable or disable UPnP function.

UPnP  Enable  Disable

---

**QoS Settings**

QoS DSCP Settings. The DSCP value can be in decimal or hexadecimal format between 0-63

DSCP Value

---

**Network Connection Check Settings**

Enable or disable the network connection check. If network connection fails, the camera will reboot automatically in response.

Enable

Figure 4-33B

### [Dynamic DNS Server Settings]

DDNS (Dynamic Domain Name System) provides a convenient way of accessing the camera when using a dynamic IP. DDNS assigns a domain name to the camera, so that the Administrator does not need to go through the trouble of checking if the IP address assigned by DHCP Server or ISP (in xDSL connection) has changed.

Before enabling the DDNS function, you should apply for a Host Name from the DDNS service provider's website. There are 2 providers listed in the camera: GeoVision DDNS Server and DynDNS.org.

#### To enable the DDNS function:

1. **Enable:** Enable the DDNS function.



2. **Service Provider:** Select the DDNS service provider you have registered with.
3. **Host Name:** Type the host name used to link to your camera. For the users of GeoVision DDNS Server, it is unnecessary to fill the field because the system will detect the host name automatically.
4. **User Name:** Type the user name used to enable the service from the DDNS.
5. **Password:** Type the password used to enable the service from the DDNS.
6. Click **Apply**.

#### [HTTP Port Settings]

The HTTP port enables connecting your camera to the Web. For security integration, the Administrator can hide the server from the general HTTP port by changing the default HTTP port **80** to a different port one within the range of **1024** through to **65535**.

#### [HTTPS Settings]

By enabling the Hypertext Transfer Protocol Secure (HTTPS) settings, you can access the camera through a secure protocol. Note the customized certification function is currently not supported in **GV-IP LPR Camera 5R, GV-LPC1100, and LPC2210 / 2211 / 2011**.

#### [Camera Streaming Port Settings]

The VSS port enables connecting your camera to the GV-System. The default setting is **10000**.

### **[UPnP Settings]**

UPnP (Universal Plug & Play) is a networking architecture that provides compatibility among networking equipment, software and peripherals of the 400+ vendors that are part of the Universal Plug and Play Forum. It means that they are listed in the network devices table for the operating system (such as Windows XP) supported by this function. Enabling this function, you can connect to the camera directly by clicking on the camera listed in the network devices table. This function is enabled by default.

### **[QoS Settings]**

The Quality of Service (QoS) is a bandwidth control mechanism that guarantees delay-sensitive data flows such as voice and video streams, obtain a certain amount of bandwidth to keep the streaming smooth.

To apply QoS to your camera, all network routers must support QoS and QoS must be enabled on these devices. To enable the QoS on the camera, enter a Differentiated Services Code Point (DSCP) value. This value is a field in an IP packet that enables different levels of services for the network traffic. When the video stream from the camera reaches a router, the DSCP value will tell the router what service level should be applied, e.g. the bandwidth amount. This value ranges from 0 to 63 in decimal format. The default value is 0 which means QoS is disabled. Click **Apply** to finish.

### **[Network Connection Check Settings]**

When the network connection check is enabled, the camera will check for Internet connection and reboots automatically when it is disconnected from the Internet. This function is enabled by default.

### 4.6.3 UMTS

Note this function is only supported by **GV-LPC1200** and **GV-LPR1200**.

UMTS stands for Universal Mobile Telephone System. UMTS is a third-generation (3G) broadband, packet-based transmission of text, digitized voice, video, and multimedia at data rates up to 2 megabits per second. UMTS offers a consistent set of services to mobile computer and phone users, no matter where they are located in the world.

After an UMTS-compatible wireless device is attached to the USB port and the UMTS function is enabled, the camera can have Internet access. For supported mobile broadband devices, see *Appendix D*.

#### UMTS Settings

In this section you can configure the UMTS settings

---

##### UMTS Settings

**Set Up UMTS Device**

Enable

PIN Number

Access Point Name (APN)

Username

Password

Maximum Transmission Unit

Retain UMTS connection

Check Interval

Check VPN Connection

Check Target IP Address

UMTS Authentication Protocol

Enable schedule mode

EnableDNS

Primary DNS:

Secondary DNS:  (Optional)

---

##### Select schedule time

Span 1

Span 2

Span 3

Weekend  Saturday and Sunday  Only Sunday

---

##### 3GConnection Status

Disconnection

Figure 4-34

---

**Note:** You need to prepare a Mini USB-to-USB cable and install in the camera. See [1.3.8 Installing a Mini USB Cable](#).

---

- **PIN number:** Type the PIN number that is provided by your network operator.
- **Access Point Name (APN):** Type Access Point Name that is provided by your network operator.
- **Username:** Type a valid username to enable the UMTS service from your network operator.
- **Password:** Type a valid password to enable the UMTS service from your network operator.
- **Maximum Transmission Unit (MTU):** Type the Maximum Transfer Unit. The default value is 1500.
- **Retain UMTS Connection:** Select this option to check the UMTS connection status and use the drop-down list to specify the desired time length for checking frequency. The camera will rebuild the connection if disconnection is detected.
- **Check VPN Connection:** Select this option to check the VPN (Virtual Private Network) connection status. To check the IP address, type the target IP address in the **Check Target IP Address** field.
- **UMTS Authentication Protocol:** Use the drop-down list to select the UMTS Authentication Protocol provided by your network operator.
- **Enable Schedule Mode:** Starts the UMTS connection automatically based on the schedule you set in the Select Schedule Time section. See [4.5.2 Recognizing Schedule Settings](#) for the same settings.
- **3G Connection Status:** Indicates the connection status of UMTS or VPN.

### 4.6.4 IP Filtering

The Administrator can set IP filtering to restrict access to the camera.

#### IP Filter Setting

In this section you can allow or deny network connection listed in the table. ( Only 4 filter entries are supported.)

**IP Filtering**

Enable IP Filtering

No.	IP Address Range in CIDR format	Action	Customize
The IP Filter has not been configured yet			

Filtered IP:  ex: 192.168.1.2 or 192.168.1.0/24

Action to take:  ▾

Figure 4-35

To enable the IP Filter function:

1. **Enable IP Filtering:** Enable the IP Filtering function.
2. **Filtered IP:** Type the IP address from which you want to restrict the access.
3. **Action to take:** Select the action of **Allow** or **Deny** to be taken by the IP address(es) you have specified.
4. Click **Apply**.

## 4.6.5 SNMP Settings

The Simple Network Management Protocol (SNMP) allows you to monitor the status of the camera through SNMP network management software.

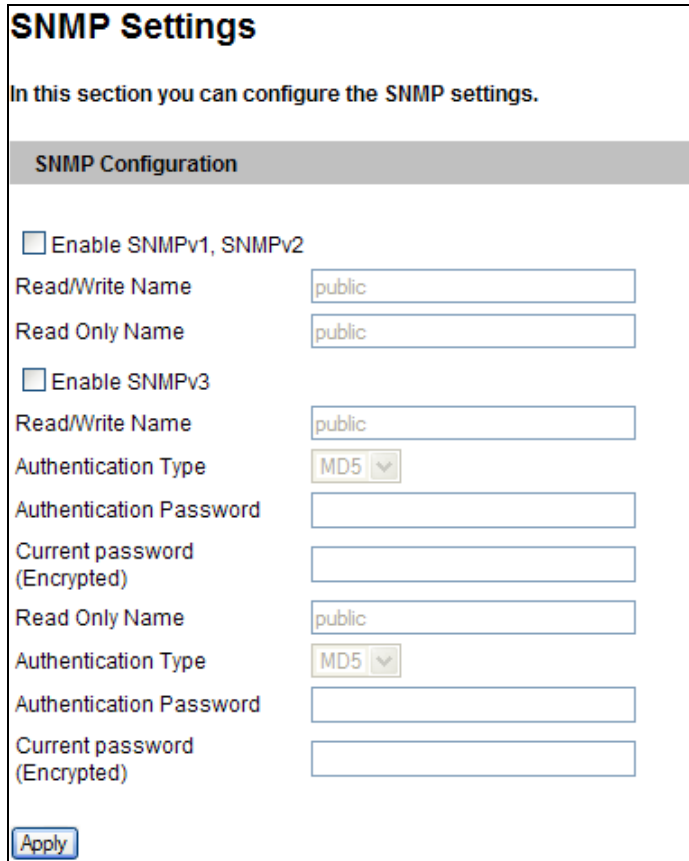

Figure 4-36

To allow management of SNMP software:

1. Select **Enable SNMPv1 SNMPv2c** to enable the function.
2. To enable access to **Read/Write Name**, type a community string. This will serve as a password to allow read and write access to the camera from the SNMP software.
3. To enable **Read Only Name**, type a community string to allow read-only access to the camera from the SNMP software.
4. For a more secured connection, select **Enable SNMPv3** to enable SNMP version 3.
5. To enable access to **Read/Write Name**, type a community string.
6. Select an **Authentication Type** to be used for SNMP requests.
7. Type the **Authentication Password** and **Current Password (Encrypted)**. You will need to type these passwords in the SNMP software to be able to access the camera.

8. To enable access to **Read Only Name**, type a community string to allows read-only access to the camera, and set up the **Authentication Type**, **Authentication Password** and the **Current Password (Encrypted)**.
9. Click **Apply** to save the settings.

## 4.7 Management

The Management section includes the settings of data and time and user account. Also you can view the firmware version and execute certain system operations.

### 4.7.1 Date and Time Settings

The date and time settings are used for date and time stamps on the image.

### Date and Time Settings

In this section you can configure time and date or just synchronize with a NTP server.

---

**Date and Time on GV-IPCAM**

Mon Aug 27 18:11:35 GMT+08:00 2012

---

**Time Zone**

(GMT+08:00) China, Hong Kong, Australia Western, Singapore, Taiwan, Russia

Enable Daylight Saving Time

Start  (MM/dd/hh/mm)

End  (MM/dd/hh/mm)

---

**Synchronized with a Network Time Server**

Synchronized with Network Time Server (NTP)

Host name or IP Address:

Update period: 24 hours; Update Time:  :

---

**Synchronized with your computer or modify manually**

Modify manually

Date  (yyyy/mm/dd)

Time  (hh:mm:ss)

Synchronized with your computer

---

**Date and time overlay setting**

Show date as

(This is a format of date where yyyy stands for year in 4 digits or yy in 2 digits, mm stands for month, and dd stands for day)

Display order

Date prior to time (Ex. 2007/05/21 17:00:00)

Time prior to date (Ex. 17:00:00 2007/05/21)

Figure 4-37



**[Date & Time on GV-IPCAM]** Displays the current date and time on the camera.

**[Time Zone]** Sets the time zone for local settings. Select **Enable Daylight Saving Time** to automatically adjust the camera for daylight saving time. Type the Start Time and End Time to enable the daylight saving function.

**[Synchronized with a Network Time Server]** By default, the camera uses the timeserver of [time.windows.com](http://time.windows.com) to automatically update its internal clock every 24 hours. You can change the host name or IP setting to the timeserver of interest. To change the time of automatic update, use the drop-down lists to specify the time.

**[Synchronized with your computer or modify manually]** Manually changes the camera date and time or synchronize its date and time with those of the local computer.

**[Date and time overlay setting]** Select the display format of date and time stamps on the image. For this function to work, you must also enable the **Overlaid with date stamps** and **Overlaid with time stamps** options in Figure 4-2B.

**Note:** When connecting to GV-System (V8.5.7.0 or later), the Daylight Saving Time of the camera can be synchronized automatically with that of GV-System by enabling **Automatically adjust DST** (Configure button < Camera Install < IP Camera Install).

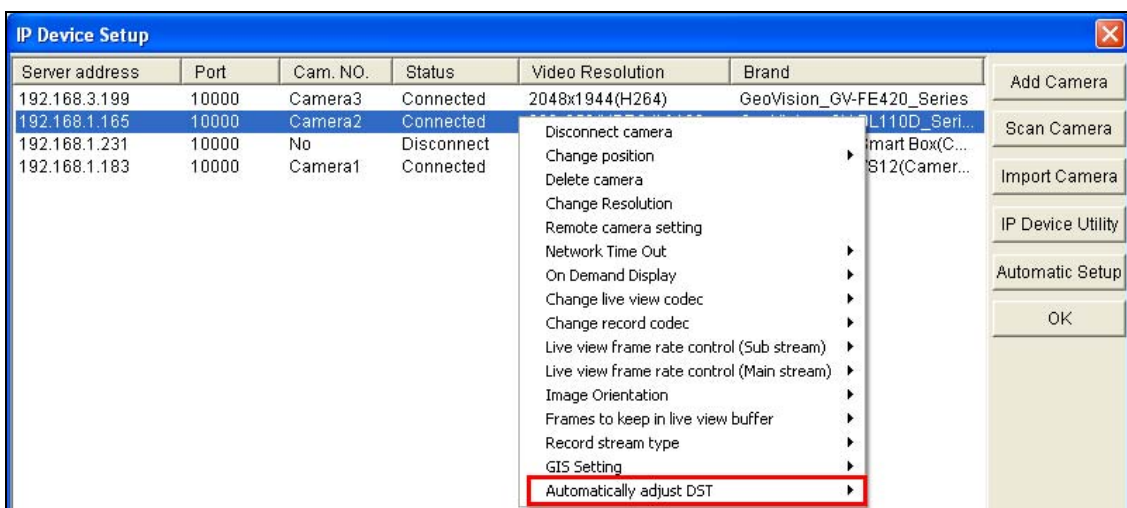

Figure 4-37-1

**GV-System:** Configure button > Camera Install > IP Camera Install

**GV-VMS:** Toolbar > Configure > Camera Install > Setup button > General Setting

## 4.7.2 Storage Settings

Note this function is only supported by **GV-LPR1200**.

You can store the recognition results or images to the memory card slot in the camera. The image is stored in the JPEG compressed format.

### Storage Settings

In this section you can configure the disk storage to archive images and events.

Storage Settings

Enable saving results on SD Card

Enable recycling

Stop recording or recycle disk when free space of disk is smaller than

Keep days (3-365)

Enable debug message to the storage.

Enable auto formatting when disk or partition is unable to record.

Disk Information

Disk No.	Total Size	Used Size	Free space	Utilization	Remove	Format
Disk11	28.830	2.060	26.769	7%	<input type="button" value="Remove"/>	<input type="button" value="Format"/>

(Unit: Gigabyte)

Figure 4-38

---

**Note:** The captured images may be lost if you do not remove the memory card properly.

---

### [Storage Settings]

- **Enable saving results on a memory Card:** Enable this option to save the recognition results or images to the memory card.
- **Enable recycling:** If this option is checked, the system will overwrite the oldest stored files when the space of the memory card is lower than the specified space. If this option is not checked, the system will stop recording when the specified space is reached.
- **Keep days (3-365):** Specify the number of days to keep the files from **3** day to **365** days. When both **Keep days** and **Enable recycling** are selected, the system applies whichever condition comes first. For example, if the specified smallest amount of storage space comes earlier than the designated keep days, then recycle is applied first.

- **Enable debug message to the storage:** Debug message (see *4.7.4 Log Information*) is deleted after reboot. Select this option to store log information to an inserted storage device.
- **Enable auto formatting when disk or partition is enabled to record:** Select this option for the camera to automatically format the storage device when there is error during saving recognition results or images.

### 4.7.3 User Account

You can change the login name and password of Administrator and Guest accounts.

- The default Administrator login name and password are **admin**.
- The default Guest login name and password are **guest**. To allow a Guest user log in without entering the username and password, select **Disable authentication for guest account**.
- To remain logged in after reboot, select **Disable auto logout after reboot**.
- The default FTP Server login name and password are **lprftpsrver**. Note the FTP function is only supported by **GV-LPR1200**.

#### User Account

In this section you can change the administrator account and password

---

##### Administrator Account

User Name:

Old Password:

New Password:

Confirm Password:

---

##### Guest User Account

User Name:

Old Password:

New Password:

Confirm Password:

---

##### FTP Server User Account

User Name:

Old Password:

New Password:

Confirm Password:

Figure 4-39

---

**Note:** You can also access this User Account interface simply by executing a CGI command. See [Appendix A](#).

---

## 4.7.4 Log Information

The log contains dump data that is used by service personnel for analyzing problems.

**Log Information**

In this section you can see all system activities.

**Debug Messages**

This section shows the data used for debugging.

```
Dec 24 09:29:24 geobox-logger-dump: (652) signal_catch[1626]: Receive Signal: 13
Dec 24 09:29:24 geobox-logger-dump: (652) signal_catch[1626]: Receive Signal: 13
Dec 24 09:29:24 geobox-logger-dump: (652) signal_catch[1626]: Receive Signal: 13
Dec 24 09:29:24 geobox-logger-dump: (652) signal_catch[1626]: Receive Signal: 13
Dec 24 09:29:24 geobox-logger-dump: (652) signal_catch[1626]: Receive Signal: 13
Dec 24 09:29:24 geobox-logger-dump: (652) signal_catch[1626]: Receive Signal: 13
Dec 24 09:29:24 geobox-logger-dump: (652) signal_catch[1626]: Receive Signal: 13
Dec 24 09:29:24 geobox-logger-dump: (652) signal_catch[1626]: Receive Signal: 13
Dec 24 09:29:24 geobox-logger-dump: (652) signal_catch[1626]: Receive Signal: 13
Dec 24 09:29:24 geobox-logger-dump: (652) signal_catch[1626]: Receive Signal: 13
Dec 24 09:29:24 geobox-logger-dump: (652) signal_catch[1626]: Receive Signal: 13
```

**System Message**

This section shows the data used for debugging.

```
(00609) (12/15/14 03:20:50 UTC): IPCAM System Starting
(00638) (12/15/14 03:20:51 UTC): Firmware Info - /project/release/snapshot/geo_imx104_release-v2.14-141025
=> Last Changed Rev: 14975
(00642) (12/15/14 03:20:51 UTC): Firmware Info - /project/release/snapshot/geo_imx104_release-v2.14-141025
/arm-boot => Last Changed Rev: 14975
(00647) (12/15/14 03:20:51 UTC): Hardware Info - Wire MAC = FFFFFFFFFF
(00652) (12/15/14 03:20:51 UTC): Hardware Info - Wireless MAC = FFFFFFFFFF
(00657) (12/15/14 03:20:51 UTC): Hardware Info - Wireless Region = 5
(00662) (12/15/14 03:20:52 UTC): Hardware Info - Hardware device id = 1094
(00667) (12/15/14 03:20:52 UTC): Hardware Info - Hardware Audio - AAC = [Not Support]
(00672) (12/15/14 03:20:52 UTC): Hardware Info - Hardware Audio - AAC = [Not Support]
```

**Notice Message**

This section shows the data used for debugging.

```
-----
(00006) Time(11/29/14 16:07:43 GMT8:00) - (GV-LPC1100) SSVR start up, firmware(v1.01 2014-10-25, 128 MB)
(00007) Time(11/29/14 16:38:10 GMT8:00) - IPCAM Starting: HW(0x0, 0x0) HID(1094) (128M) (Sat Oct 25
02:34:22 CST 2014)
(00008) Time(11/29/14 16:38:23 GMT8:00) - (GV-LPC1100) SSVR start up, firmware(v1.01 2014-10-25, 128 MB)
(00009) Time(11/29/14 17:08:51 GMT8:00) - IPCAM Starting: HW(0x0, 0x0) HID(1094) (128M) (Sat Oct 25
02:34:22 CST 2014)
(00010) Time(11/29/14 17:09:04 GMT8:00) - (GV-LPC1100) SSVR start up, firmware(v1.01 2014-10-25, 128 MB)
(00011) Time(11/29/14 17:39:31 GMT8:00) - IPCAM Starting: HW(0x0, 0x0) HID(1094) (128M) (Sat Oct 25
02:34:22 CST 2014)
(00012) Time(11/29/14 17:39:44 GMT8:00) - (GV-LPC1100) SSVR start up, firmware(v1.01 2014-10-25, 128 MB)
(00013) Time(12/01/14 16:46:37 GMT8:00) - IPCAM Starting: HW(0x0, 0x0) HID(1094) (128M) (Sat Oct 25
02:34:22 CST 2014)
(00014) Time(12/01/14 16:46:51 GMT8:00) - (GV-LPC1100) SSVR start up, firmware(v1.01 2014-10-25, 128 MB)
(00015) Time(12/01/14 18:52:21 GMT8:00) - IPCAM Starting: HW(0x0, 0x0) HID(1094) (128M) (Sat Oct 25
02:34:22 CST 2014)
(00016) Time(12/01/14 18:52:34 GMT8:00) - (GV-LPC1100) SSVR start up, firmware(v1.01 2014-10-25, 128 MB)
(00017) Time(12/01/14 19:15:11 GMT8:00) - IPCAM Starting: HW(0x0, 0x0) HID(1094) (128M) (Sat Oct 25
```

Figure 4-40

## 4.7.5 Tools

This section allows you to execute certain system operations and view the firmware version.

### Additional Tools

In this section you can set the additional tools

---

#### Host Settings

In this section you can determine a hostname and camera name for identification.

Host Name

---

#### Auto Reboot Setup

In this section you can set the system's auto reboot time.

Enable

Day Interval  days

RebootTime  :

---

#### Firmware Update

In this section you can see GV-IPCAM firmware version.

---

#### System Settings

Restore to factory default settings

Restore to factory default settings(Except network)

---

#### Internal Temperature

Internal Temperature Normal Range: 0°C ~ 95°C "(32°F ~ 203°F)"

Current chipset temperature inside camera is  °C/  °F

---

#### Fan Status

Ensbles

---

#### Reboot

Do you wish to reboot now?

Figure 4-41

**[Host Settings]** Enter a descriptive name for the camera.

**[Auto Reboot Setup]** Select **Enable** to activate automatic reboot and specify the time for reboot in the sub fields below.

- **Day Interval:** Type the day interval between the reboots.
- **Reboot Time:** Use the drop-down list to specify the time for automatic reboot.

**[Firmware Update]** This field displays the firmware version of the camera.

**[System Settings]** Click a **Load Default** button to restore the factory default settings with the network settings restored or not restored.

---

**Note:** After applying the default function, the default network connection will be DHCP or fixed IP (192.168.0.10) if the router does not support DHCP. Re-configure your network settings if necessary.

---

**[Internal Temperature]** This field displays the current chipset temperature inside the camera.

**[Fan Status]** This field shows whether the fan of the camera is enabled or not. Note this function is only supported by **GV-LPC1200 / GV-LPR1200**.

**[Reboot]** Click the **Reboot** button to reset the software configuration of the camera.

## 4.7.6 Language

You can select the language for the Web interface.

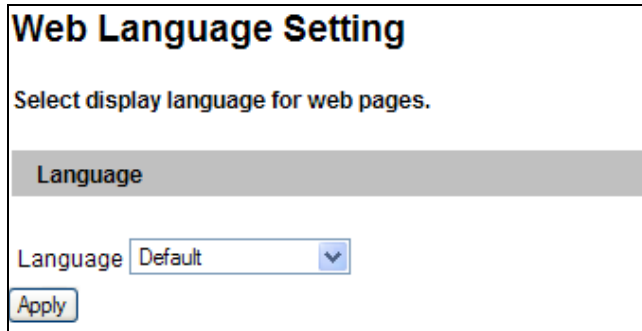

**Web Language Setting**

Select display language for web pages.

**Language**

Language

*Figure 4-42*

Use the Language drop-down list to select a language for the Web interface. By default, the language on the Web interface will be the same with the one used for the operating system.



## Chapter 5 Advanced Applications

This chapter introduces more advanced applications.

### 5.1 Upgrading System Firmware

GeoVision periodically updates the latest firmware to the company website. You can update your camera firmware through the Web interface or GV-IP Device Utility included in the Software DVD.

#### Important Notes before You Start

Before you start updating the firmware, please read these important notes:

1. While the firmware is being updated, the power supply must not be interrupted.

---

**WARNING:** The interruption of power supply during updating causes not only update failures but also damages to your camera. In this case, please contact your sales representative and send your device back to GeoVision for repair.

---

2. Do not turn the power off within 10 minutes after the firmware has been updated.
3. If you use GV-IP Device Utility for firmware upgrade, the computer used to upgrade firmware must be under the same network as the camera.
4. Stop monitoring the camera.
5. Stop all the remote connections including Center V2, VSM (Vital Sign Monitor), ViewLog Server and 3GPP/RTSP.
6. Stop the connection to GV-System.
7. If firmware upgrade fails, you will need to restore the camera to its default settings. For details, see *5.3 Restoring to Factory Default Settings*.

### 5.1.1 Using the Web Interface

1. In the Live View window, click the **Show System Menu** button (No. 8, Figure 3-2) and select **Remote Config**. This dialog box appears.

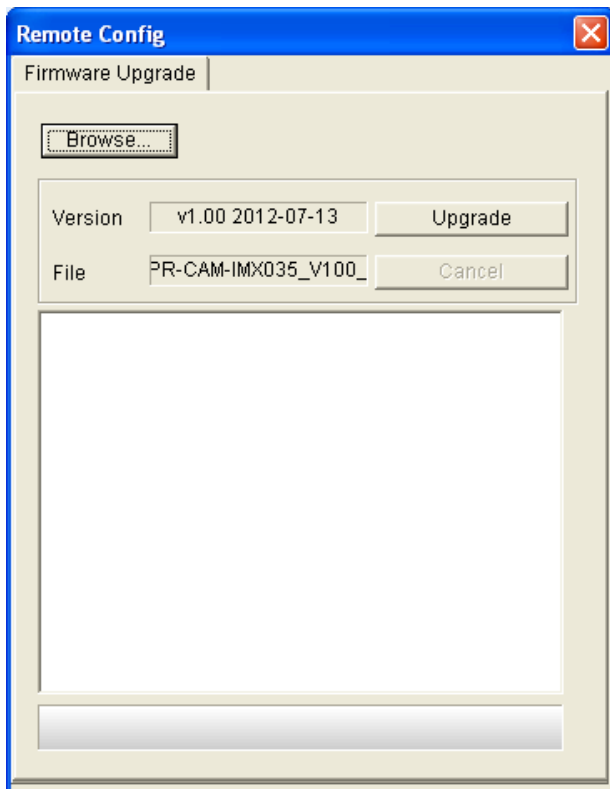

Figure 5-1

2. Click the **Browser** button to locate the firmware file (.img) saved at your local computer.
3. Click the **Upgrade** button to start upgrading.

### 5.1.2 Using the GV-IP Device Utility

The GV-IP Device Utility provides a direct way to upgrade the firmware to multiple cameras. Note the computer used to upgrade firmware must be under the same network with the cameras.

1. Insert the Software DVD, select **GV IP Device Utility**, and follow the onscreen instructions to install the program.
2. Double-click the **GV IP Device Utility** icon created on your desktop. This dialog box appears.

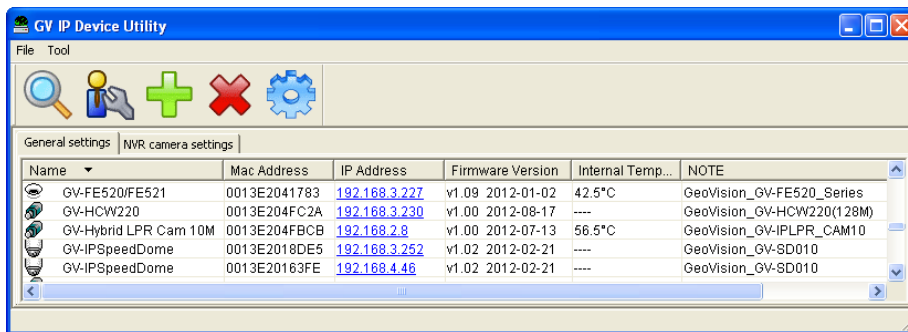

Figure 5-2

3. Click the **Search** button to locate the IP devices on the LAN or click the **New** button and assign the IP address to locate a camera on the network. Or highlight one IP device in the list and click the **Delete** button to remove it.

- Click on the IP address of the camera and select **Configure**. This dialog box appears.

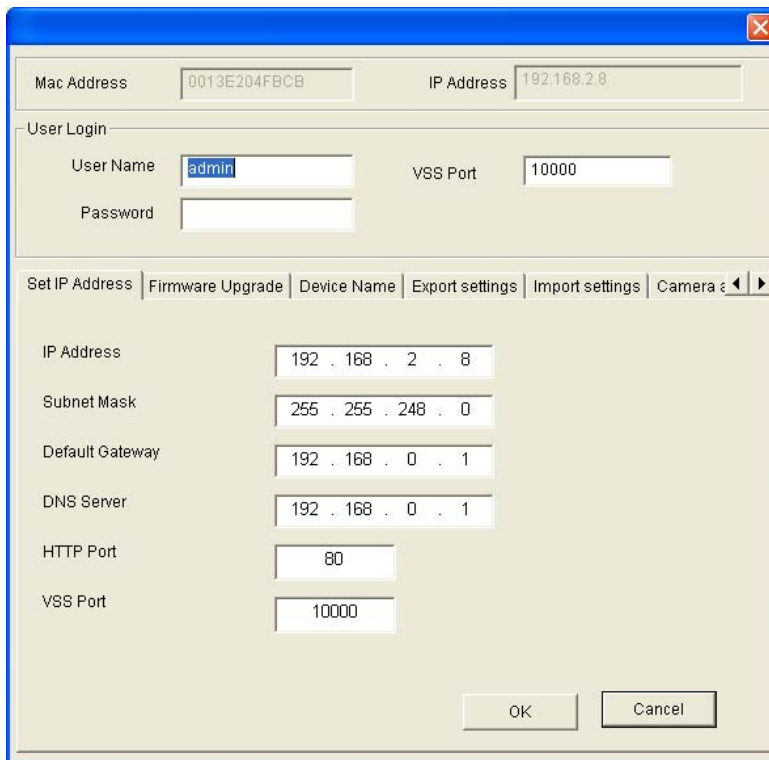

Figure 5-3

- Click the **Firmware Upgrade** tab. This dialog box appears.

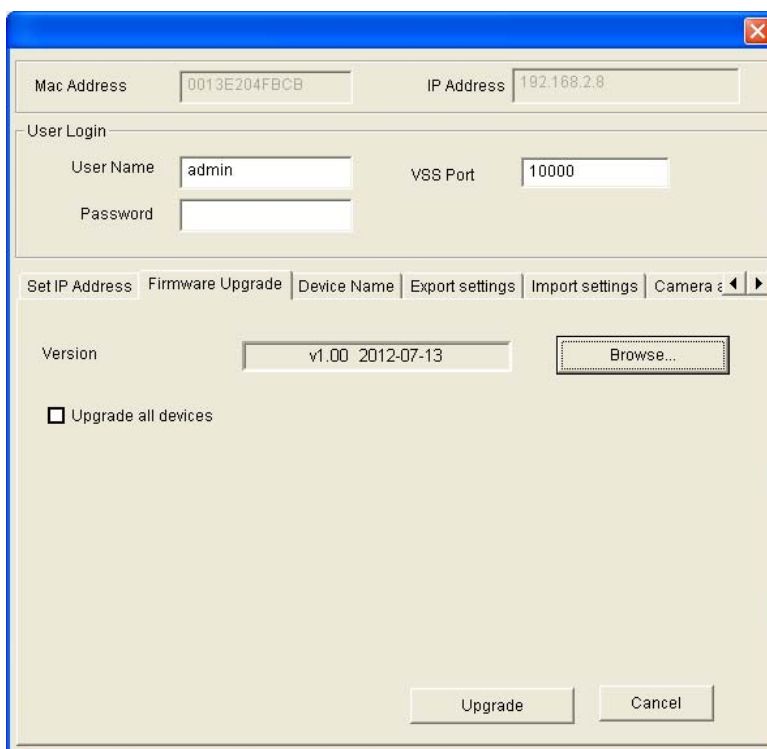

Figure 5-4

- Click the **Browse** button to locate the firmware file (.img) saved at your local computer.

6. If you like to upgrade all the cameras in the list, check **Upgrade all devices**.
7. Type **Password**, and click **Upgrade** to start the upgrade.

## 5.2 Backing Up and Restoring Settings

With the GV-IP Device Utility included on the GV-IP LPR Camera Software CD, you can back up the configurations in the camera, and restore the backup data to the current unit or import it to another unit.

### To back up the settings

1. Run **GV IP Device Utility** and locate the desired camera. See Steps 1-3 in 5.1.2 *Using the GV-IP Device Utility*.
2. Double-click the camera in the list. Figure 5-3 appears.
3. Click the **Export Settings** tab. This dialog box appears.

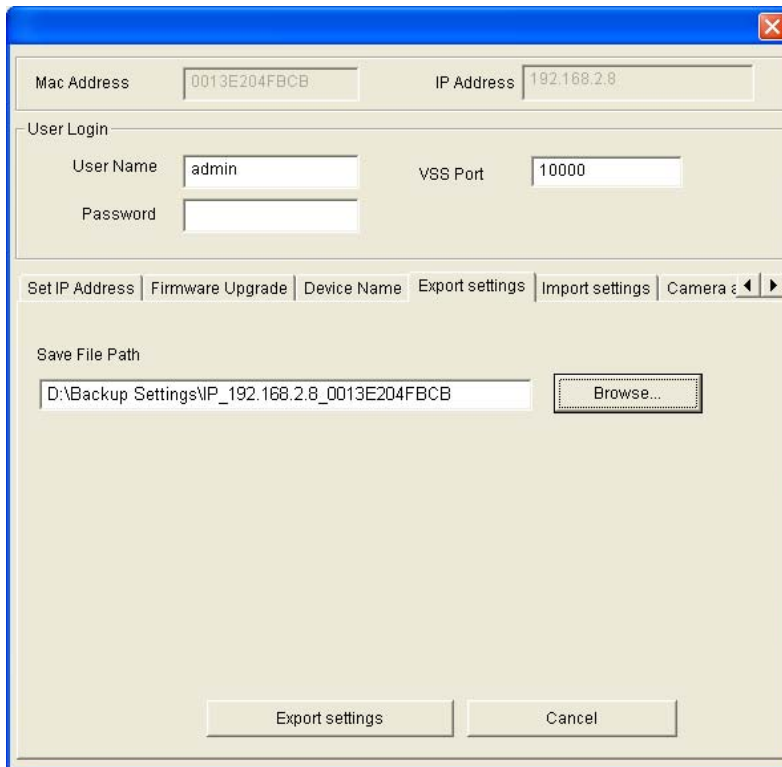

Figure 5-5

4. Click the **Browse** button to assign a file path.
5. Type **Password**, and click **Export Settings** to save the backup file.

## To restore the settings

1. In Figure 5-3, click the **Import Settings** tab. This dialog box appears.

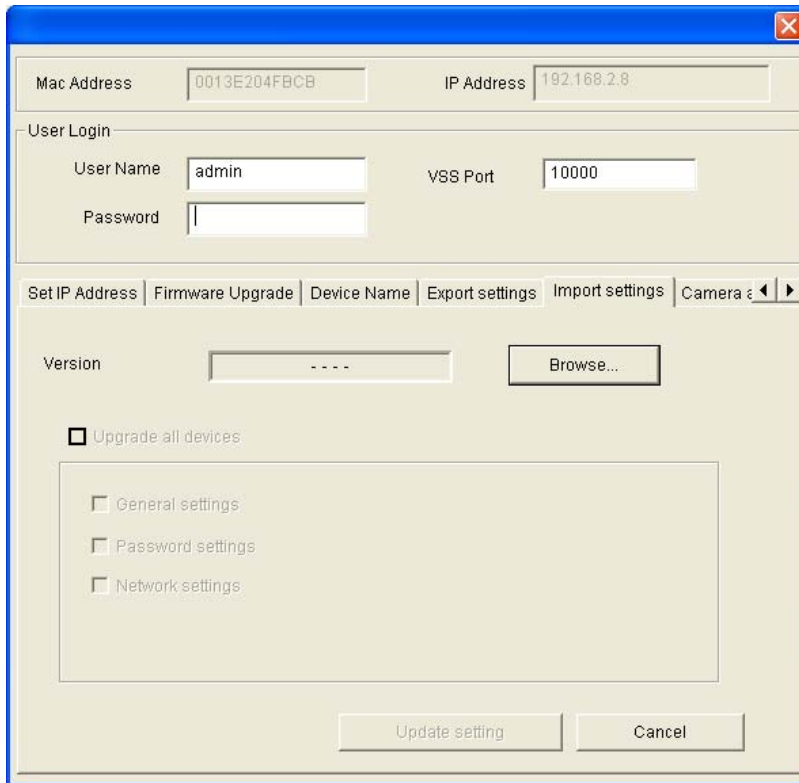

Figure 5-6

2. Click the **Browse** button to locate the backup file (.dat).
3. Select **Upgrade all devices** to import the settings into the same type of device in the same LAN. To import password settings and/or network settings, select **Password Settings** and/or **Network settings**.
4. Click the **Upgrade setting** button to start restoring.

## 5.3 Restoring to Factory Default Settings

To restore the factory default settings, you can use the camera's Web interface or operate directly on the camera.

### 5.3.1 Using the Web Interface

Follow the steps below to restore the factory default settings through the camera's Web interface.

1. In the left menu of the Web interface, Click **Tools**.
2. In **System Settings** field, click the **Load Default** button to restore the factory default settings.

### 5.3.2 Directly on the Camera

You can alternatively press the default button inside the camera.

1. Keep the power and network cables connected to the camera.
2. Loosen the camera's cover.
3. Press and hold the default button for 8 seconds.

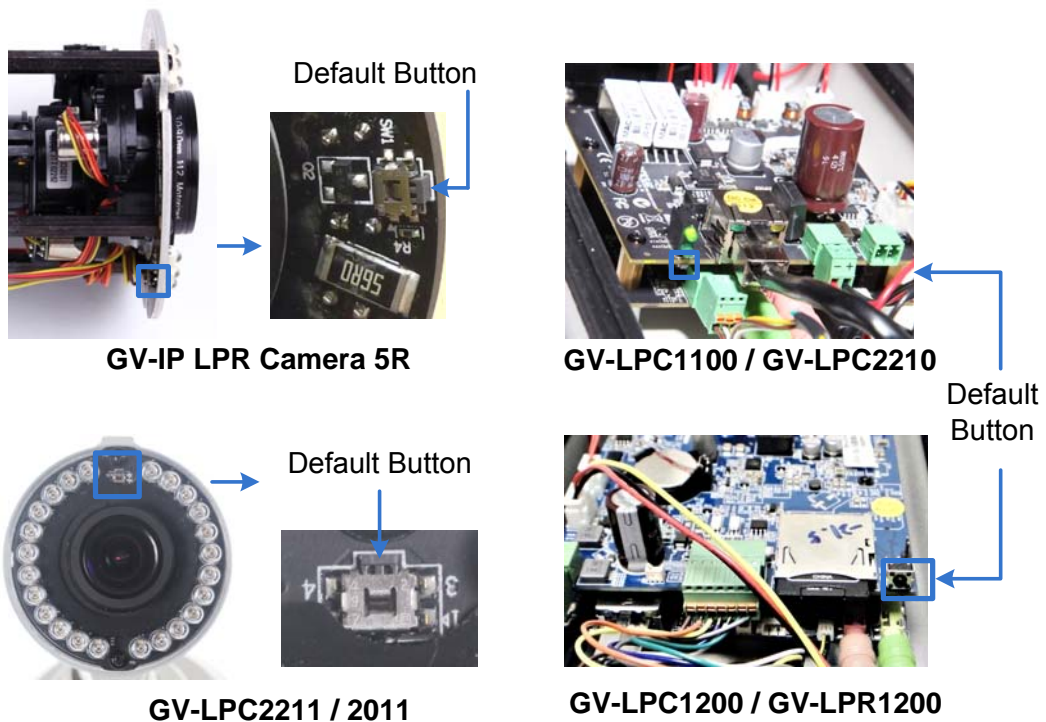

Figure 5-7



4. Release the default button. When the process of loading default settings is completed, the camera reboots automatically.
5. Insert a new Silica Gel bag and fasten the camera's cover immediately. For details, see *Replacing Silica Gel Bag* in the respective camera section in Chapter 1.

## 5.4 Verifying Watermark

Note this function is not available in GV-LPC 2211 / 2011. The watermark is an encrypted and digital signature embedded in the video stream during the compression stage, protecting the video from the moment of creation. Watermarking ensures that an image is not edited or damaged after it is recorded. To enable the watermark function, see *Watermark Setting, 4.1.1 Video Settings*.

The Watermark Proof is a watermark-checking program. It can verify the authenticity of the recording before you present it in court.

### 5.4.1 Accessing AVI Files

To verify watermark, access the recorded AVI files by one of the following methods:

1. Use the **File Save** function (No. 6, Figure 3-2) to start recording on the local computer.
2. Locate recorded files on the GV-System.

### 5.4.2 Running Watermark Proof

1. Install **Watermark Proof** from the GV-IP LPR Camera Software CD. After installation, a **WMPProof** icon is created on your desktop.
2. Double-click the created icon. The Water Mark Proof window appears.
3. Click **File** from the menu bar, select **Open** and locate the recording (.avi). The selected recording is then listed on the window. Alternatively, you can drag the recording directly from the storage folder to the window.
4. If the recording is unmodified, a check mark will appear in the **Pass** column. On the contrary, if the recording is modified or does not contain watermark during recording, a check mark would appear in the **Failed** column. To review the recording, double-click the listed file on the window.

### 5.4.3 The Watermark Proof Window

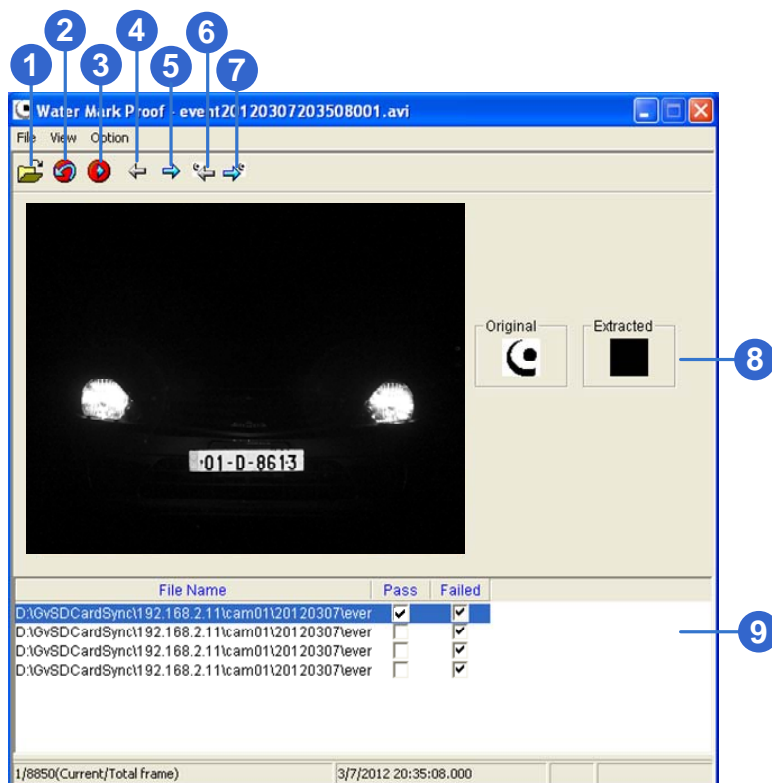

Figure 5-8

The controls in the window:

No.	Name	Description
1	Open File	Opens the recording.
2	First Frame	Goes to the first frame of the file.
3	Play	Plays the file.
4	Previous Frame	Goes to the previous frame of the file.
5	Next Frame	Goes to the next frame of the file.
6	Previous Watermarked Frame	Goes to the previous frame that contains watermark.
7	Next Watermarked Frame	Goes to the next frame that contains watermark.
8	Original vs. Extracted	The Extracted icon should be identical with the Original icon. If not, it indicates the recording has been tampered.
9	File List	Displays the proof results.

## Chapter 6 DVR Configurations

The GV-IP LPR Camera can deliver live view images, date and time or even recognized plate numbers to the GV-System (GV-DVR/NVR) / GV-VMS for security surveillance. The following is the integration specifications:

- Regarding the compatible GV-System and GV-VMS versions for your camera, refer to *System Requirements* in Chapter 1 for respective cameras.
- The camera allows for up to **8** streams of connection.
- When a camera is connected to a Web browser or any other applications, it takes up **1** stream; when it is connected to GV-System, it takes up **2** streams. When GV-LPR1200 is connected to GV-ASManager, it takes up **2** streams.

---

**Note:**

1. By default, the camera is in dual streams and will take up 2 streams when connected to GV-System / GV-VMS.
2. GV-System (GV-DVR/NVR) / GV-VMS can turn out to be a license plate recognition system PC LPR when installed with LPR Plugin program and GV-LPR Capture Dongle. The recognition function is only supported on GV-VMS V15.10 or later.

- 
- The hardware compression and the “Pre-Recording Using RAM” feature cannot work on the videos from the camera. For details about the “Pre-Recording Using RAM” feature, see *System Configuration*, Chapter 1, *DVR User’s Manual* on the GV-NVR Software DVD.

## 6.1 Setting Up IP Cameras on GV-System

Follow the steps below to manually connect your camera to GV-System.

---

**Note:** The following instructions are based on V8.5.7.0 software and user interfaces.

---

1. On the GV-System's main screen, click the **Configure** button, select **System Configure**, select **Camera Install** and click **IP Camera Install**. This dialog box appears.

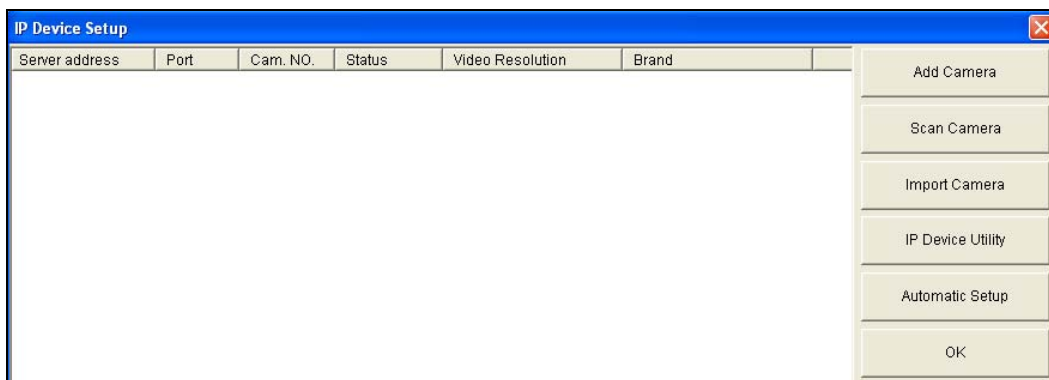

Figure 6-1

- To automatically set up an IP camera, click **Scan Camera** to detect any IP cameras on the same LAN.
- To manually set up an IP camera, click **Add Camera**.
- To import IP cameras from the GV-IP Device Utility, click **Import Camera**.
- To map IP devices through the GV-IP Device Utility program, click **IP Device Utility**.
- To add all IP cameras within the IP address range, click **Automatic Setup**.

2. Click **Add Camera**. This dialog box appears.

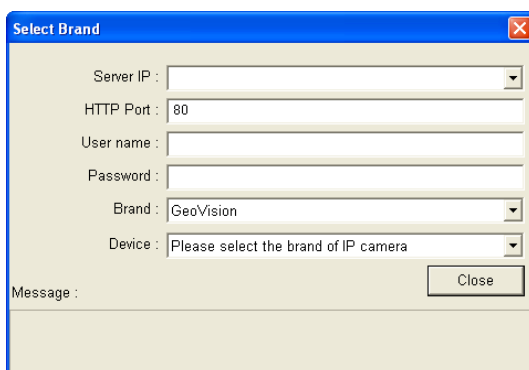

Figure 6-2

3. Type the IP address, username and password of the camera. Modify the default HTTP port if necessary.

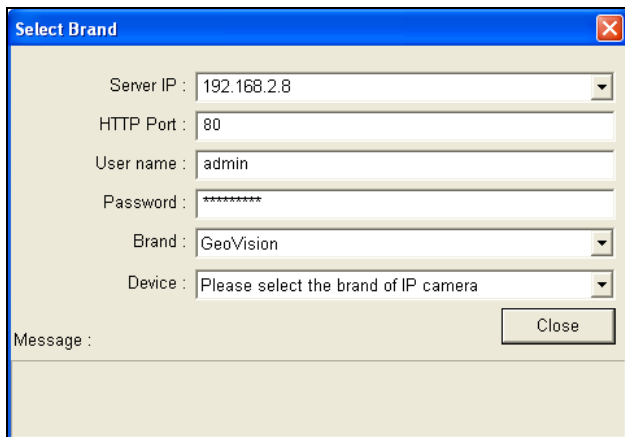

Figure 6-3

4. Select **GeoVision** from the Brand drop-down list and select your camera from the Device drop-down list. This dialog box appears.

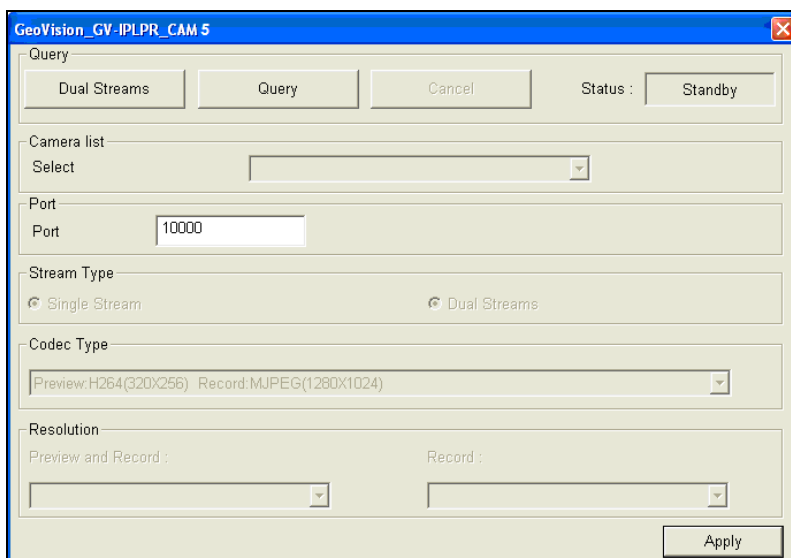

Figure 6-4

- **Dual Streams:** Click this button to set the codec type to MJPEG in the main stream and to H.264 in the sub stream with the resolutions listed below.
  - **Port:** Modify the video streaming port number if necessary.
  - **Stream Number:** Click the **Query** button and select **Single Stream** or **Dual Streams**.
  - **Codec type:** The live view codec and resolution settings are displayed here.
  - **Resolution:** Select resolutions for preview and recording.
5. Click **Apply**. The camera is added to the list.

6. Click the listed camera, select **Display position** and select a channel number to map the camera to a channel on the GV-System.

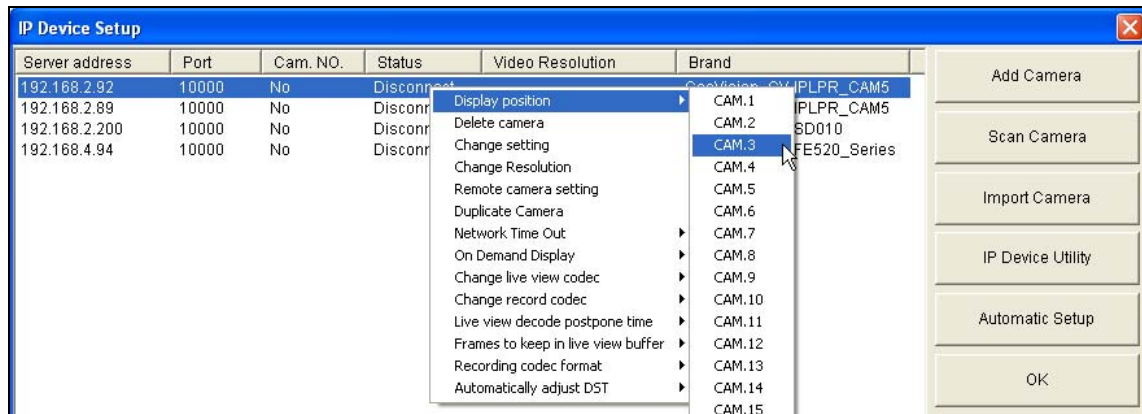

Figure 6-5

7. The Status column now should display "Connected". Click **OK**. The dome view is displayed on the selected channel of GV-System.

## 6.1.1 Customizing Camera Settings

After the camera is connected and assigned with a display channel, you can configure the camera's settings such as frame rate, codec type and resolution. Right-click the camera to see the following list of options:

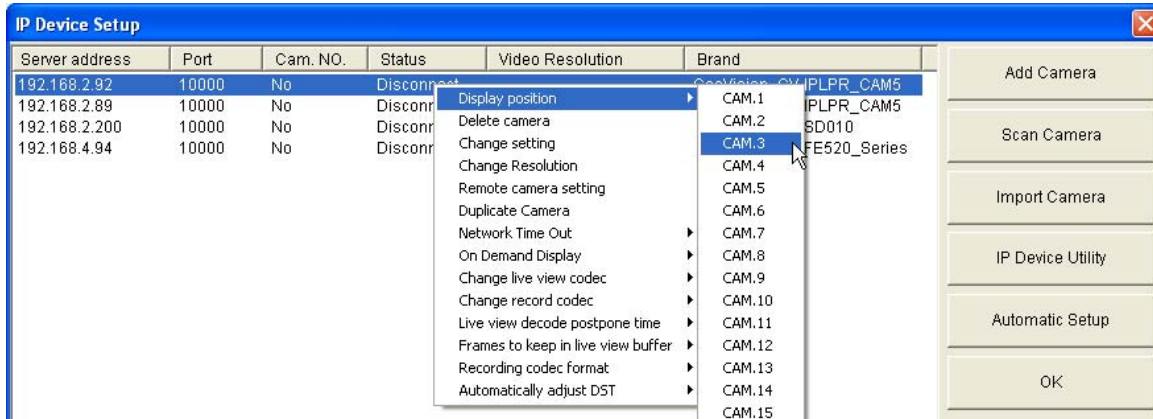

Figure 6-6

- **Change Setting:** Changes the IP address, port number, username and password of the camera. This function is only available when the camera is disconnected.
- **Change Resolution:** Changes the display ratio, live view resolution and record resolution.
- **Remote camera setting:** Accesses the configuration interface of the connected camera.
- **Network Time Out:** When network disconnection exceeds the specified time period, the camera status will be displayed as Connection Lost.
- **On Demand Display:** Enables automatic adjustment of live view resolution and produces good image quality without causing high CPU usage.
- **Change live view codec:** Changes the live view codec.
- **Change record codec:** Changes the recording codec.
- **Live view decode postpone time:** Specifies the number of milliseconds to postpone live view decoding. When network connection with the camera is unstable or when the time length between frames is not evenly distributed, postponing the live view decoding will make the video smoother.
- **Frames to keep in live view buffer:** Specifies the number of frames to keep in the live view buffer.
- **Recording Codec Format:** Specifies whether to record in standard or GeoVision type of JPEG, H.264 codec.





- **Automatically Adjust DST:** If enabled, the time on the camera's Web interface will be synchronized with the time of the GV-System when DST period starts or ends on the GV-System.

## 6.2 Setting Up IP Cameras on GV-VMS

Follow the steps below to manually connect your camera to GV-VMS.

### Note:

1. The License Plate Recognition function is not supported on GV-VMS.
2. The following instructions are based on V14.10 software and user interfaces.

1. To access the IP Device Setup page, click **Home** , select **Toolbar** , click **Configure**  and select **Camera Install**.

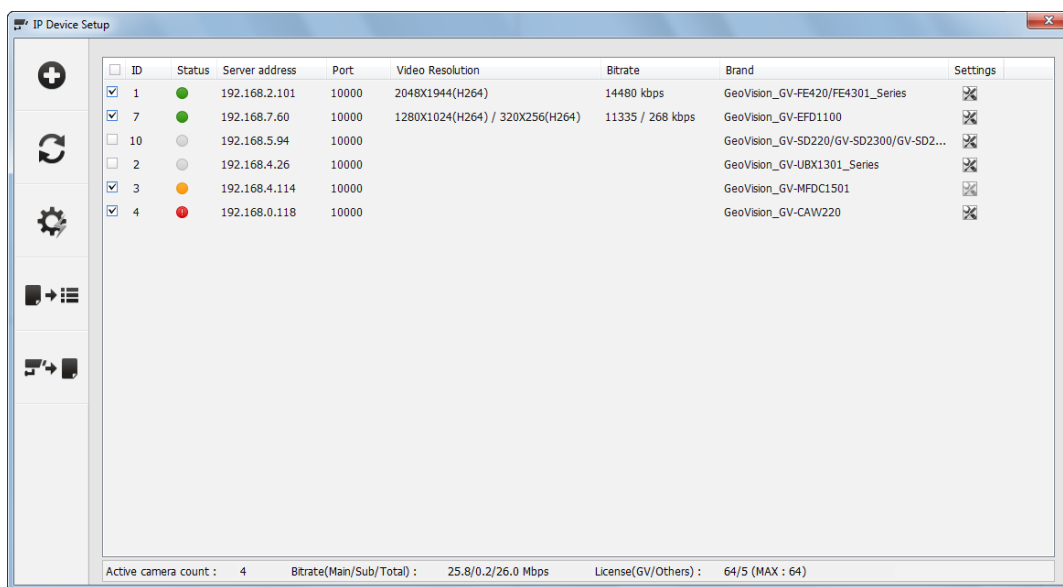

Figure 6-7

2. Click **Add Camera** . This dialog box appears.

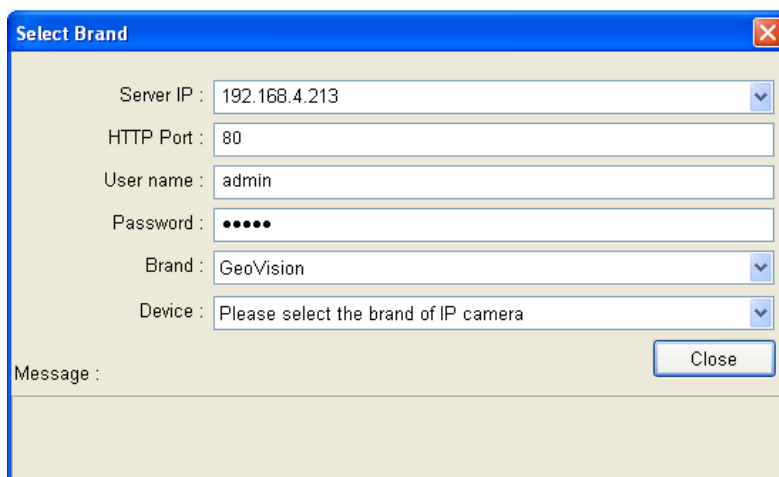

Figure 6-8

3. Type the IP address, username and password of the IP camera. Modify the default HTTP port **80** if necessary.
4. Select a camera brand and model name from the **Brand** and **Device** drop-down lists respectively. This dialog box appears.

---

**Note:** For the GV-IP LPR Camera 5R, select **GV-IPLPRCam5**.

---

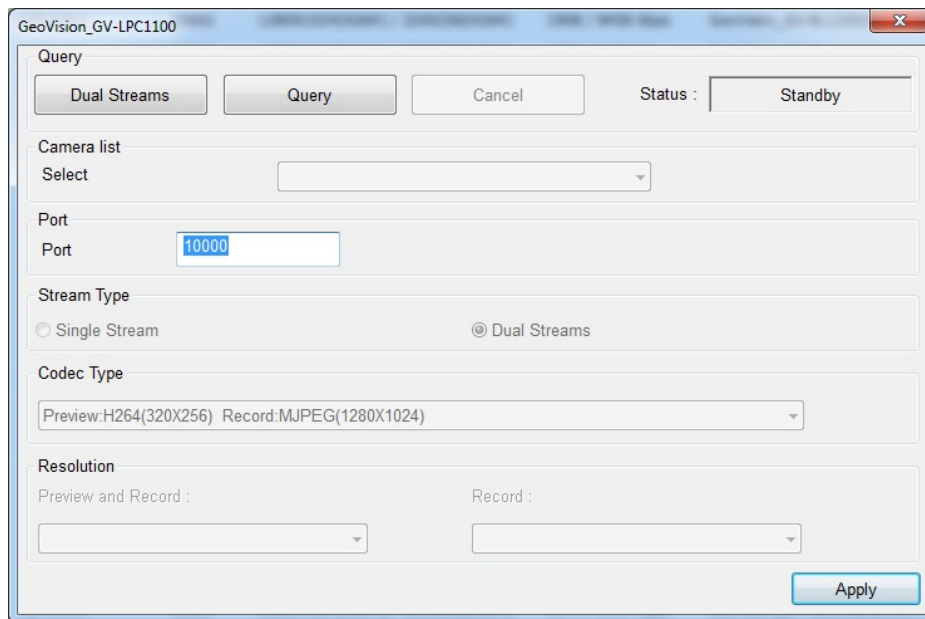

*Figure 6-9*

5. In the dialog box, configure the options which may vary depending on camera brands.
  - **Dual Streams:** The camera is set to dual streams by default. Select this option to apply the dual-streaming settings (lower resolution for live view and higher resolution for recording) if the camera supports dual streams.
  - **Query:** Detect and apply the current codec and resolution setting on the camera. This function may not be available for some third-party cameras.
  - **Camera list:** Select a camera number.
  - **Port:** Modify the video streaming port number if necessary.
  - **Stream Type:** You may have the option of **Single Stream** or **Dual Streams** depending on camera models.
  - **Codec Type:** You may have different codec options depending on camera models. If the selected camera supports dual streaming, the live view codec and recording codec can be set differently.
  - **Resolution:** You may select the different resolutions for live view and recording.
6. Click **Apply** to add the IP camera to the IP Device List.
7. To connect the added camera, click the box besides the **ID** column. Upon successful connection, the **Status** icon shows green, with the video resolution and bit rate being displayed in the correspondent columns.







<input type="checkbox"/>	ID	Status	Server address	Port	Video Resolution	Bitrate	Brand	Setting
<input checked="" type="checkbox"/>	1		192.168.3.151	10000	1920X1080(H264) / 448X252(H264)	6902 / 51 kbps	GeoVision_GV-BX5200/BX5300_Series	
<input checked="" type="checkbox"/>	2		192.168.6.15	10000	1920X1080(H264) / 448X252(H264)	6854 / 137 kbps	GeoVision_GV-BX2200/BX2300_Series	
<input checked="" type="checkbox"/>	3		192.168.7.101	10000			GeoVision_GV-BL1500	

Figure 6-10

## 6.3 Remote Monitoring with Multi View

Note that Multi View is only supported by **GV-IP LPR Camera 5R / GV-LPC1100**. You can monitor the live view of the camera using the Multi View.

### Connecting to the Camera

The Multi View program is available in the GV-System applications, and is also included in the Software DVD as an independent program. The following is an example of running the Multi View through WebCam Server on the GV-System.

1. To enable the remote access to the GV-System, click the **Network** button, select **WebCam Server** to display the Server Setup dialog box, and click **OK** to start the WebCam server.
2. At the local computer, open the Web browser and type the IP address of the GV-System. The Single View page appears.
3. Select **Multi View** and the desired viewing resolution. The valid user name and password are required for login. For the first-time user, you will be directed to the Download page. Install the Multi View program before you can run it.
4. On the Multi View window, click the **Edit Host** button. The Edit Host window appears.
5. To create a host, click the **New** button. You need to create a group before creating a host.

6. Select **GV-IP Camera**, **GV-IP Speed Dome** from the Device drop-down list. Type the host name, IP address, user name and password of the camera. Modify the default VSS port **10000** if necessary.

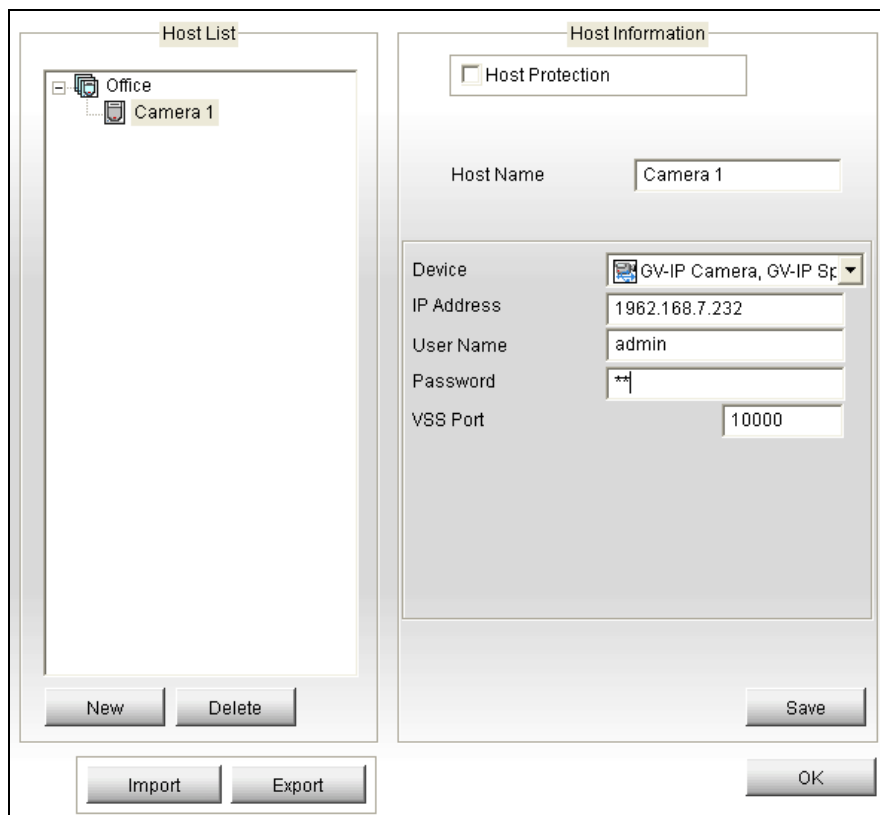

Figure 6-11

7. Click **Save** to establish connection.

For details on the Multi View functions, see *Multi View Viewer*, Chapter 8, *DVR User's Manual* on the GV-NVR Software DVD.

## 6.4 Remote Monitoring with E-Map

You can use the Remote E-Map to monitor the camera.

### Creating an E-Map for the Camera

With the E-Map Editor, you can create an E-Map for the camera. The E-Map Editor is available in the two applications: Main System and E-Map Server. The following is an example of running the E-Map Editor from the Main System.

1. Go to Windows **Start** menu, point to **Programs**, select **GV folder** and click **E-Map Editor**.
2. To create an E-Map, click the **Add Map** button on the toolbar. A New Map file appears.
3. Double-click the New Map file, and click the **Load Map** button on the toolbar to import a graphic file.
4. To create a host, click the **Add Host** button on the toolbar and select **Add Video Server**.
5. Right-click the created New Host in the Host View, and select **Host Settings**. This dialog box appears.

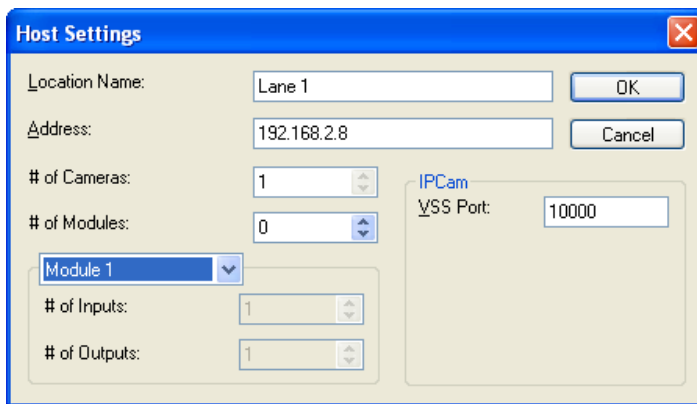

Figure 6-12

6. Give the camera a location name, and type its IP address (or domain name). Keep the default VSS port **10000**, or modify it to match that of the camera.
7. Click **OK** to save the settings.
8. Expand the created host folder. Drag and drop the camera icon onto the imported E-Map.
9. Close the E-Map Editor. Click **Yes** when you are prompted to save the file.

For details on creating an E-Map file on the E-Map Server, see *E-Map Server*, Chapter 9, *DVR User's Manual* on the GV-NVR Software DVD.

## Connecting to the Camera

Depending on where you save the created E-Map file (GV-System, E-Map Server or Control Center), the steps to open the Remote E-Map window for monitoring may vary slightly. The following is the connection example when you store the E-Map file in the GV-System.

1. To enable the remote access to the GV-System, click the **Network** button, select **WebCam Server** to display the Server Setup dialog box, and click **OK** to start the WebCam server.
2. At the local computer, open the Web browser and type the address of the GV-System. The Single View page appears.
3. Select **Remote eMap**. The valid user name and password are required for login. For the first-time user, you will be directed to the Download page. Install the E-Map program before you can run it.
4. On the Remote E-Map window, click the **Login** button and select the camera host to access its videos. The valid user name and password are required to log in the camera.

For details on the Remote E-Map functions, see *The Remote E-Map Window*, Chapter 9, *DVR User's Manual* on the GV-NVR Software DVD.



## Chapter 7 CMS Configurations

This section introduces the related settings to enable connecting to the camera in the central monitoring stations Center V2 and VSM and Dispatch Server.

### 7.1 Center V2

The Center V2 can monitor the camera.

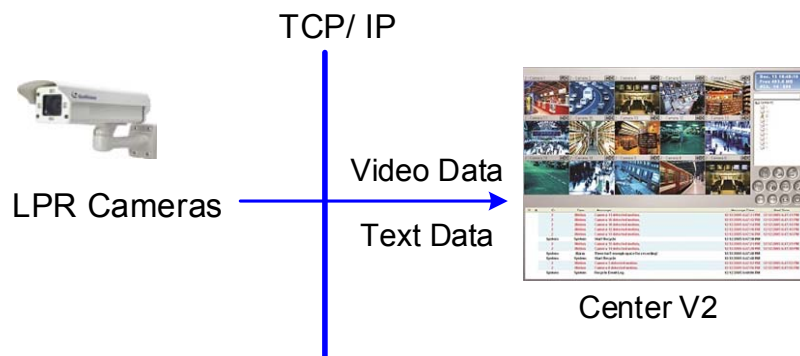

Figure 7-1

- To set the appropriate port connecting to the camera, click the **Preference Settings** button, select **System Configure**, click the **Network** tab, and check **Accept connections from GV-Compact DVR, Video Server & IP Cam**. Keep the default port **5551** for the Port 2 option, or modify it to match the Center V2 port on the camera.

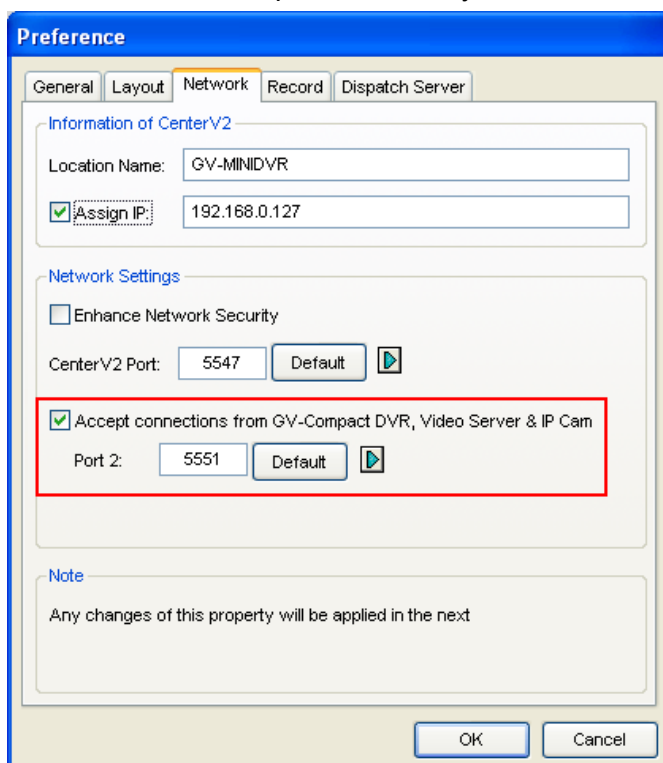

Figure 7-2

- To define how to display the received video on motion detection, click the **Preference Settings** button and select **System Configure**. This dialog box appears.

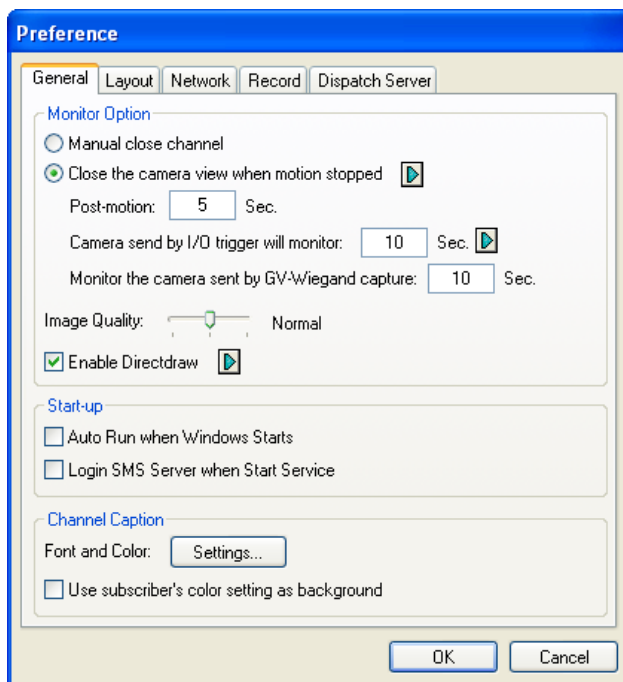

Figure 7-3

- **Manual close channel:** Closes the triggered camera view manually.
- **Close the camera view when motion stopped:** Closes the triggered camera view automatically when motion stops.
- **Post Motion:** Specify the duration of the camera view remaining on the monitoring window after motion stops.
- **Camera send by I/O trigger will monitor:** This feature is functional for cameras with I/O function only.

For further information on how to manage the received video from the camera, see *GV-CMS Series User's manual*.

## 7.2 Vital Sign Monitor

The Vital Sign Monitor can monitor the camera.

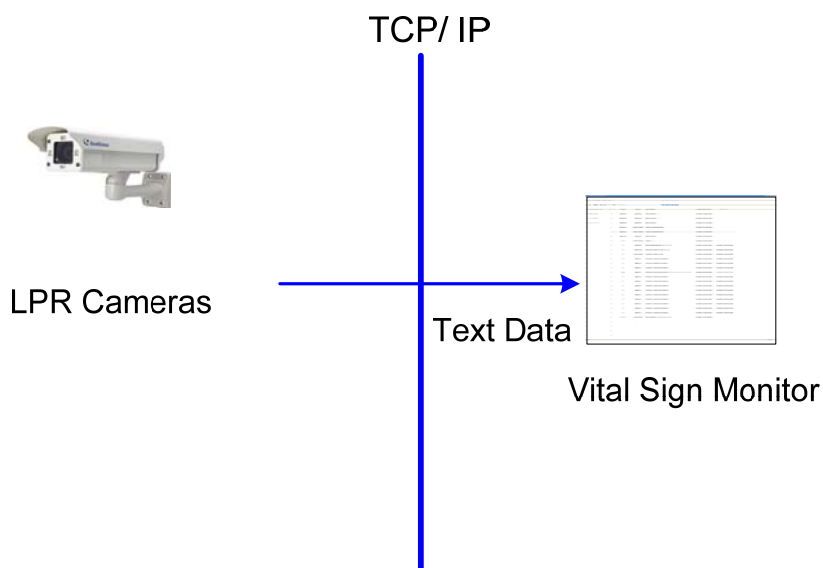

Figure 7-4

- To set the appropriate port connecting to the camera, click **Configure** on the window menu, and select **System Configure** to display this dialog box. In the Connective Port field, keep the default value **5609** for the Port 2 option, or modify it to match the VSM port on the camera.

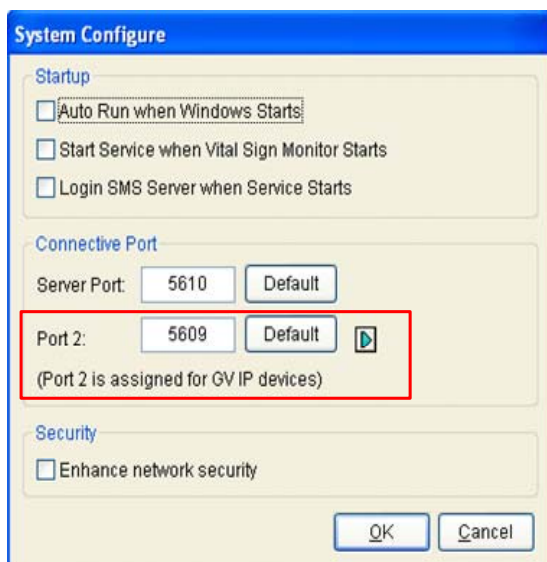

Figure 7-5

For further information on how to manage the received video from the camera, see *GV-CMS Series User's manual*.

## 7.3 Dispatch Server

The Dispatch Server can manage the camera and distribute them to the Center V2.

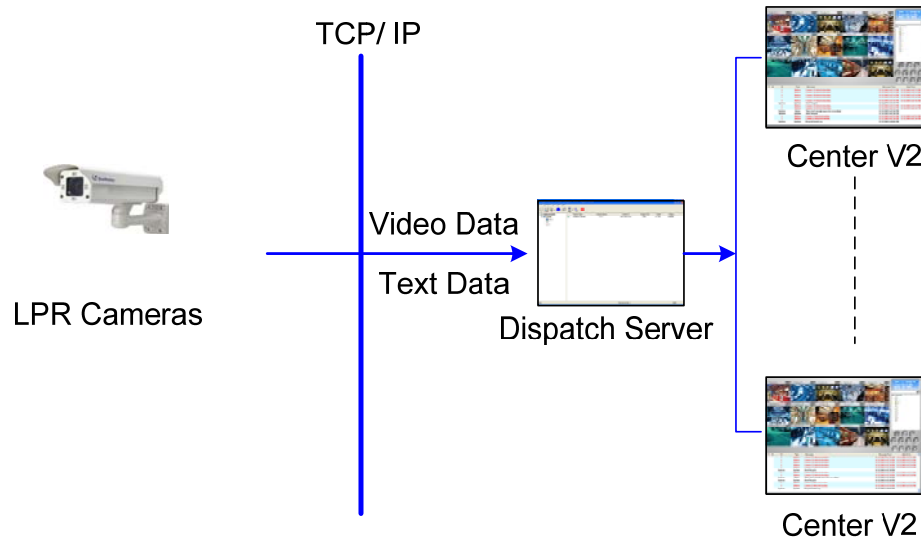

Figure 7-6

- To enable connecting to the camera, click the **Server Setting** button on the toolbar, and enable **Allow GV IP devices to login as subscriber from Port**. Keep the default port **5551**, or modify it to match the Center V2 port on the camera.

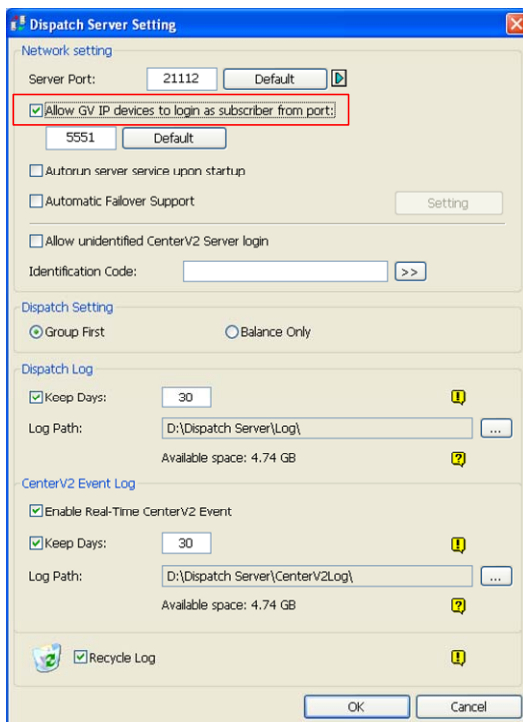

Figure 7-7

For further information on how to manage the received video from the camera, see *GV-CMS Series User's manual*

## Chapter 8 Smart Device Connection

You can access the live view on your mobile devices using the mobile application GV-Eye. Android Smartphone, tablet, iPad, iPhone and iPod Touch are supported.

For details on system requirements, installation and setup, visit our website:

[http://www.geovision.com.tw/english/5\\_8\\_App.asp](http://www.geovision.com.tw/english/5_8_App.asp)

## Chapter 9 GV-ASManager Connection

GV-LPR1200 and PC LPR can recognize license plates detected in the video source, and send the LPR results to GV-ASManager. Access can be granted when the detected license plate numbers match the vehicles registered in GV-ASManager's database. Before setting up GV-LPR1200 on GV-ASManager, see *4.3.10 Registry Database* to enable the Registry Database for data comparison.

---

**Note:**

1. GV-LPR1200 is only compatible with GV-ASManager V4.3.0.0 or later.
  2. GV-LPC2210 is only compatible with GV-ASManager V4.3.5.0 or later
  3. For GV-IP LPR Camera 5R / GV-LPC1100 / GV-LPC1200 / GV-LPC2210 / 2211 / 2011, you can connect the camera to PC LPR system to perform the license recognition.
- 

Follow the steps below to add GV-LPR1200 to GV-ASManager.

1. On the menu bar, click **Setup** and select **Devices**. This dialog box appears.

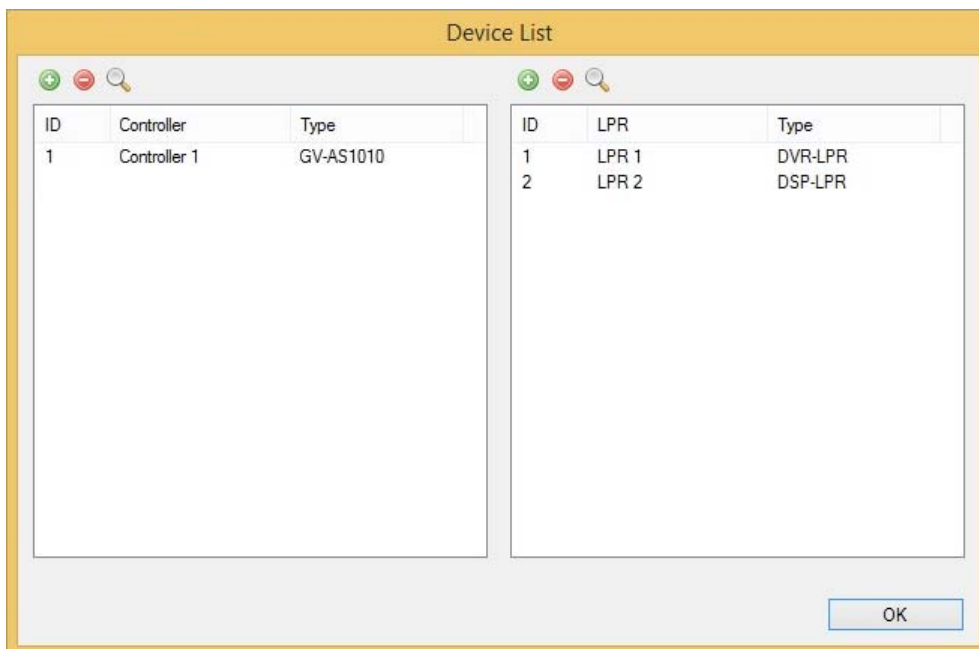

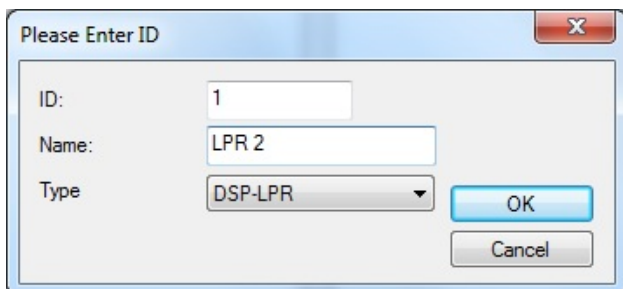

Figure 9-1

**Note:** You can also click the **Search** button  to search for GV-LPR1200 detected under the same LAN.

2. On the right pane for LPR, click the **Add** button . This dialog box appears.



The dialog box titled "Please Enter ID" contains the following fields and controls:

- ID:** A text input field containing the value "1".
- Name:** A text input field containing the value "LPR 2".
- Type:** A dropdown menu currently showing "DSP-LPR".
- Buttons:** "OK" and "Cancel" buttons are located at the bottom right of the dialog.

Figure 9-2

3. Type an **ID** number and **Name** for the LPR.
4. Use the drop-down list to select **DSP-LPR**.
5. Click **OK**. The LPR Setup page appears.

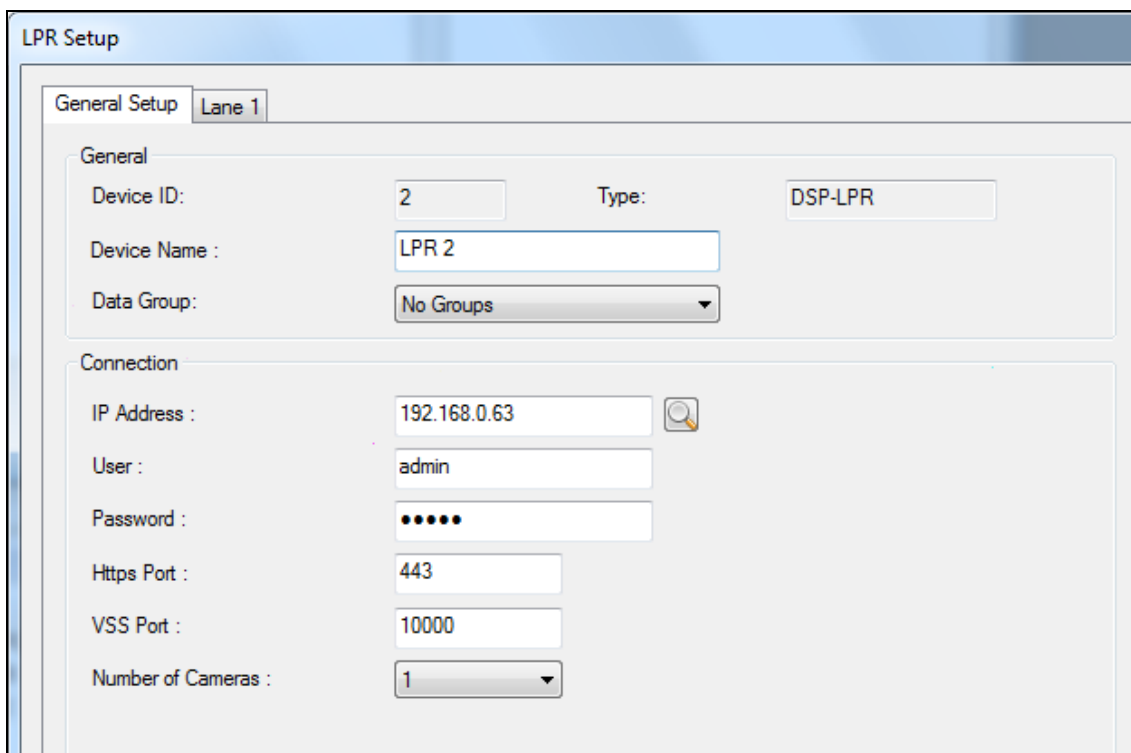

The "LPR Setup" dialog box is divided into two sections: "General Setup" and "Connection".

**General Setup** (Lane 1):

- General:**
  - Device ID:** 2
  - Type:** DSP-LPR
  - Device Name:** LPR 2
  - Data Group:** No Groups

**Connection:**

- IP Address:** 192.168.0.63
- User:** admin
- Password:** [masked with dots]
- Https Port:** 443
- VSS Port:** 10000
- Number of Cameras:** 1

Figure 9-3

6. Assign the GV-LPR1200 to a **Data Group** if needed or select **No Groups** to disable the data group function. You can then allow or forbid a user to read / write / execute the functions assigned under the data group. Refer to *8.1 Setting Up System User*, Chapter 8 in *GV-ASManager User Manual* for more details.
7. Under Connection, type the **IP Address**, **User** name and **Password** of the GV-LPR1200. You can also click the **Search** button  to search for GV-LPR1200 detected in the same LAN.
8. You can modify the following settings if necessary.
  - **Https Port:** The default Https port is 443.
  - **VSS Port:** The default VSS port is 10000.

For the details on connecting GV-LPR1200 to GV-ASManager, see *13.3.2 Step 2: Adding GV-GV-DSP LPR to GV-ASManager* and *13.3.3 Step 3: Configuring a Channel*, Chapter 13 in *GV-ASManager's User Manual*.

For details on creating a vehicle database, see *13.4 Adding Vehicles*, Chapter 13 in *GV-ASManager's User Manual*.



## Specifications

### GV-IP LPR Camera 5R

Camera		
Image Sensor	1/3" B/W progressive scan CMOS	
Picture Elements	1280 (H) x 1024 (V)	
Camera Type	B/W	
Shutter Speed	Automatic, Manual (1/500 ~ 1/8000 sec)	
White Balance	Auto / Manual (2800K ~ 8500K)	
S/N Ratio	50 dB	
Max. Speed	60 km/h (37 mph)	
Lens		
Megapixel	1.3 MP	
Lens Type	Motorized varifocal lens	
Focal Length	3 ~ 9 mm	
Maximum Aperture	F/1.2	
Mount	Ø14 mm	
Image Format	1/2.7"	
Operation	Focus	Auto Focus
	Zoom	3x Optical Zoom
	Iris	DC drive
IR LED Quantity	12	
Max. IR Distance	5 m (16.4 ft.)	
Operation		
Video Compression	H.264, MJPEG	
Video Stream	Dual streams from H.264 and MJPEG	
Frame Rate	30 fps at 1280 x 1024 *The frame rate and the performance may vary depending on the number of connections and data bitrates (different scenes)	
Image Setting	Brightness, Contrast, Sharpness, Gamma, Image Orientation, Shutter Speed, Defog, Zoom, Focus Change	
Audio Support	N/A	

Video Resolution		
Main Stream	4:3	1280 x 960, 640 x 480, 320 x 240
	16:9	1280 x 720, 640 x 360, 448 x 252
	5:4	1280 x 1024, 640 x 512, 320 x 256
Sub Stream	4:3	640 x 480, 320 x 240
	16:9	640 x 360, 448 x 252
	5:4	640 x 512, 320 x 256
TV-Out	N/A	
Network		
Interface	10/100 Base-T Ethernet, RJ-45 connector	
Protocol	DHCP, DynDNS, FTP, HTTP, HTTPS, NTP, ONVIF (Profile S), PSIA, QoS (DSCP), RTSP, SMTP, SNMP, TCP, UDP, UPnP, 3GPP/ISMA	
Mechanical		
Temperature Detector	Yes	
Camera Angle Adjustment	Pan	0° ~ 360°
	Tilt	90° ~ 180°
	Rotate	0° ~ 360°
Connectors	Power	PoE
	Ethernet	RJ-45
	Audio	N/A
	Digital I/O	N/A
LED Indicator	No	
General		
Operating Temperature	-20°C ~ 50°C (-4°F ~ 122°F)	
Humidity	10% ~ 90% (non-condensing)	
Power Source	PoE+ (IEEE802.3at)	
Max. Power Consumption	16.6 W	
Dimensions	Camera Body	289.02 x 87.75 x 148.95 mm (11.4 x 3.45 x 5.86")
	Cable Length	1 m (3.28 ft)
	Max. Cable Diameter	ø 7.1 mm (0.28")
	Max. Connector Diameter	ø 25.2 mm (0.99")
Weight	1.4 kg (3.08 lb)	

<b>General</b>	
<b>Ingress Protection</b>	IP67
<b>Vandal Resistance</b>	IK10 for metal casing
<b>Fan</b>	Constantly On
<b>Regulatory</b>	CE, FCC, C-Tick, RoHS compliant
<b>Power over Ethernet</b>	
<b>PoE Standard</b>	IEEE 802.3at Power over Ethernet / PD
<b>PoE Power Supply Type</b>	End-Span
<b>PoE Power Output</b>	DC 48V, 345mA (16.6 W Max.)
<b>Web Interface</b>	
<b>Installation &amp; Management</b>	Web-based configuration
<b>Firmware Upgrade</b>	Remote upgrade through Web Browser or GV-IP Device Utility included in the Software DVD
<b>Access from Web Browser</b>	Live View, Video Quality, Bandwidth Control, Image Snapshot, Picture in Picture, Picture and Picture, Privacy Mask, Text Overlay
<b>Language</b>	Arabic / Bulgarian / Czech / Danish / Dutch / English / Finnish / French / German / Greek / Hebrew / Hungarian / Indonesian / Italian / Japanese / Lithuanian / Norwegian / Persian / Polish / Portuguese / Romanian / Russian / Serbian / Simplified Chinese / Slovakian / Slovenian / Spanish / Swedish / Thai / Traditional Chinese / Turkish
<b>Applications</b>	
<b>Network Storage</b>	GV-System (GV-DVR/NVR), GV-VMS, GV-Recording Server
<b>Smart Device Access</b>	- GV-Eye for Android and iOS - Embedded 3GPP/ISMA browser
<b>Live Viewing</b>	IE, Chrome, Firefox, Edge, Safari, GV-MultiView
<b>CMS Server support</b>	GV-Control Center, GV-Center V2, GV-Vital Sign Monitor
<b>Note:</b> All specifications are subject to change without notice.	

## GV-LPC1100

Camera		
Image Sensor	1/3" B/W progressive scan CMOS	
Picture Elements	1280 (H) x 1024 (V)	
Camera Type	B/W	
Shutter Speed	Automatic, Manual (1/500 ~ 1/8000 sec)	
White Balance	Auto / Manual (2800K ~ 8500K)	
S/N Ratio	50 dB	
Max. Speed	120 km/h (75 mph)	
Lens		
Megapixel	1.3 MP	
Lens Type	Motorized varifocal lens	
Focal Length	9 ~ 22 mm	
Maximum Aperture	F/1.2	
Mount	Ø14 mm	
Image Format	1/2.7"	
Operation	Focus	Auto Focus
	Zoom	3x Optical Zoom
	Iris	P-Iris
IR LED Quantity	4 high power IR LEDs	
IR Distance	8 ~ 10 m (26.2 ~ 32.8 ft)	
Operation		
Video Compression	H.264, MJPEG	
Video Stream	Dual streams from H.264 and MJPEG	
Frame Rate	30 fps at 1280 x 1024 *The frame rate and the performance may vary depending on the number of connections and data bitrates (different scenes)	
Image Setting	Brightness, Contrast, Sharpness, Gamma, Image Orientation, Shutter Speed, Defog	
Audio Compression	G.711, AAC (Optional)	
Audio Support	Two-way audio	

Video Resolution		
Main Stream	4:3	1280 x 960, 640 x 480, 320 x 240
	16:9	1280 x 720, 640 x 360, 448 x 252
	5:4	1280 x 1024, 640 x 512, 320 x 256
Sub Stream	4:3	640 x 480, 320 x 240
	16:9	640 x 360, 448 x 252
	5:4	640 x 512, 320 x 256
TV-Out		NTSC, PAL BNC connector (640 x 480 resolution)
Network		
Interface		10/100 Base-T Ethernet, RJ-45 connector
Protocol		DHCP, DynDNS, FTP, HTTP, HTTPS, NTP, ONVIF (Profile S), PSIA, QoS (DSCP), RTSP, SMTP, SNMP, TCP, UDP, UPnP, 3GPP/ISMA
Mechanical		
Temperature Detector		Yes
Camera Angle Adjustment	Pan	0° ~ 360°
	Tilt	90° ~ 180°
Connectors	Power	DC 48V, High PoE (PoE++, 120 W)
	Ethernet	RJ-45
	Audio	1 In (externally connecting a microphone) 1 Out (Stereo phone jack, 3.5 mm / 0.14")
	Digital I/O	1 In / 1 Out
	TV-Out	BNC connector (640 x 480 resolution) *The TV-Out function only works in 640 x 480 resolution. For TV-Out to work properly, you must set the video resolution to 1280 x 1024 or lower. If both streams are enabled, the Sub Stream must be set to 640 x 480.
LED Indicator		N/A

General		
<b>Operating Temperature</b>	-40°C ~ 50°C (-40°F ~ 122°F)	
<b>Humidity</b>	10% ~ 90% (non-condensing)	
<b>Power Source</b>	DC 48V 2.5A, High PoE (PoE++, 120 W)	
<b>Max. Power Consumption</b>	50 W	
<b>Dimensions</b>	<b>Without support rack</b>	406 x 145 x 109 mm (16" x 5.7" x 4.3")
	<b>Cable Length</b>	1 m (3.28 ft)
<b>Weight</b>	<b>With support rack</b>	3.32 kg (7.32 lb)
	<b>Without support rack</b>	2.62 kg (5.78 lb)
<b>Ingress Protection</b>	IP67	
<b>Vandal Resistance</b>	IK10 for metal casing	
<b>Heater On</b>	-40°C ~ 8°C (-40°F ~ 46.4°F)	
<b>Fan</b>	Constantly On	
<b>Regulatory</b>	CE, FCC, C-Tick, RoHS compliant	
Power over Ethernet		
<b>PoE Standard</b>	High Power Over Ethernet / PD	
<b>PoE Power Supply Type</b>	Mid-Span	
<b>PoE Power Output</b>	DC 48V, 2.5A (120 W Max.)	
Web Interface		
<b>Installation &amp; Management</b>	Web-based configuration	
<b>Firmware Upgrade</b>	Remote upgrade through Web Browser GV-IP Device Utility included in the Software DVD	
<b>Access from Web Browser</b>	Live View, Video Quality, Bandwidth Control, Image Snapshot, Audio, Picture in Picture, Picture and Picture, Privacy Mask, Text Overlay	
<b>Language</b>	Arabic / Bulgarian / Czech / Danish / Dutch / English / Finnish / French / German / Greek / Hebrew / Hungarian / Indonesian / Italian / Japanese / Lithuanian / Norwegian / Persian / Polish / Portuguese / Romanian / Russian / Serbian / Simplified Chinese / Slovakian / Slovenian / Spanish / Swedish / Thai / Traditional Chinese / Turkish	

## Specifications

Application	
<b>Network Storage</b>	GV-System (GV-DVR/NVR), GV-VMS, GV-Recording Server
<b>Smart Device Access</b>	- GV-Eye for Android and iOS - Embedded 3GPP/ISMA browser
<b>Live Viewing</b>	IE, Chrome, Firefox, Edge, Safari, GV-MultiView
<b>CMS Server support</b>	GV-Control Center, GV-Center V2, GV-Vital Sign Monitor
GV-PA482	
<b>PoE Standard</b>	High Power Over Ethernet (PoE++) / PSE
<b>PoE Power Output</b>	DC 48V, 2.5A (120 W Max.)
<b>Ethernet Cable Length</b>	Max 100 m (32.8 ft) from GV-PA482 to IP device, CAT5e
<b>Power Input</b>	AC 100V ~ 240V, 2.5A
<b>Operating Temperature</b>	-10°C ~ 50°C (14°F ~ 122°F)
<b>Dimensions (L x W x H)</b>	43 x 69 x 40 mm (1.69 x 2.72 x 1.57")
<b>Weight</b>	130 g (0.29 lb)
<b>Note:</b> All specifications are subject to change without notice.	

## GV-LPC1200 / LPR1200

Camera		
<b>Image Sensor</b>	Megapixel B/W progressive scan CCD	
<b>Picture Elements</b>	1280 (H) x 720 (V)	
<b>Camera Type</b>	B/W	
<b>Shutter Speed</b>	Automatic: 1/1000 ~ 1/10000 sec Manual: 1/250 ~ 1/2000 sec	
<b>S/N Ratio</b>	52 dB	
<b>Max. Speed</b>	200 km/h (124.27 mph)	
Lens		
<b>Megapixel</b>	1 MP	
<b>Lens Type</b>	Motorized varifocal lens	
<b>Focal Length</b>	4.7 mm ~ 47 mm	
<b>Maximum Aperture</b>	F/3.5	
<b>Image Format</b>	1.3"	
<b>Horizontal FOV</b>	59.9° ~ 6.4°	
<b>Operation</b>	<b>Focus</b>	Auto
	<b>Zoom</b>	10x optical zoom
	<b>Iris</b>	Auto
<b>IR LED Quantity</b>	8 high power IR LEDs	
<b>IR Distance</b>	10 ~ 20 m (32.8 ~ 65.6 ft)	
Operation		
<b>Video Compression</b>	H.264, MJPEG	
<b>Video Stream</b>	Dual streams from H.264 and MJPEG	
<b>Frame Rate</b>	30 fps at 1280 x 720 *The frame rate and the performance may vary depending on the number of connections and data bitrates (different scenes)	
<b>Image Setting</b>	Brightness, Contrast, Sharpness, Gamma, Image Orientation, Shutter Speed, Defog, Maximum Video Gain	
<b>Audio Compression</b>	G.711, AAC (Optional)	
<b>Audio Support</b>	Two-way audio	



Video Resolution		
Main Stream	1280 x 720 (16:9)	
Sub Stream	640 x 360 (16:9)	
TV-Out	BNC connector (640 x 480 resolution)	
Network		
Interface	10/100/1000 Base-T Ethernet, RJ-45 connector	
Protocol	DHCP, DynDNS, FTP, HTTP, HTTPS, NTP, ONVIF (Profile S), PSIA, QoS (DSCP), RTSP, SMTP, SNMP, TCP, UDP, UPnP, 3GPP/ISMA	
Mechanical		
Temperature Detector	Yes	
Camera Angle Adjustment	Pan	0° ~ 330°
	Tilt	0° ~ 90°
Connectors	Power	DC 12V
	Ethernet	RJ-45
	Audio	1 In (microphone jack, 3.5 mm / 0.14") 1 Out (stereo phone jack, 3.5 mm / 0.14")
	Digital I/O	2 In / 2 Out
	RS-485	<b>For GV-LPR1200 recognition data output only:</b> RS-485+ / RS-485-
	Local Storage	<b>For GV-LPR1200 only:</b> Micro SD card slot (SD/SDHC, SD version 2.0 only, Class 10) * <b>SDXC</b> and <b>UHS-I</b> card types are not supported. * GV-LPR1200 does not record videos to the memory card.
	TV-Out	BNC connector (640 x 480 resolution)
	Mini USB	Mini USB port on the circuit board (for UMTS)
LED Indicator	N/A	

General		
<b>Operating Temperature</b>	-40°C ~ 50°C (-40°F ~ 122°F)	
<b>Humidity</b>	10% ~ 90% (non-condensing)	
<b>Power Source</b>	DC 12V, 5A	
<b>Max. Power Consumption</b>	54 W	
<b>Dimensions</b>	<b>Without support rack</b>	406 x 145 x 109 mm (16" x 5.7" x 4.3")
	<b>Cable Length</b>	1 m (3.28 ft)
<b>Weight</b>	<b>With support rack</b>	3.32 kg (7.32 lb)
	<b>Without support rack</b>	2.62 kg (5.78 lb)
<b>Ingress Protection</b>	IP67	
<b>Vandal Resistance</b>	IK10 for metal casing	
<b>Heater On</b>	-40°C ~ 5°C (-40°F ~ 41°F)	
<b>Fan</b>	Constantly On	
<b>Regulatory</b>	CE, FCC, RCM, RoHS compliant	
<b>Region of License Plate</b>	<b>For GV-LPR1200 only:</b> Australia / Austria / Belgium / Brazil / Bulgaria / Chile / China / Columbia / Cyprus / Czech / France / Germany / Guernsey / Hungary / Ireland / Italy / Israel / Mexico / New Zealand / Hong Kong / Norway / Holland / Poland / Portugal / Qatar / Russia / South Africa / Spain / Taiwan / UK / USA / Slovakia / Argentina	
Web Interface		
<b>Installation &amp; Management</b>	Web-based configuration	
<b>Firmware Upgrade</b>	Remote upgrade through Web Browser GV-IP Device Utility included in the Software DVD	
<b>Access from Web Browser</b>	Live View, Video Quality, Bandwidth Control, Image Snapshot, Audio, Picture in Picture, Picture and Picture, Text Overlay	
<b>Language</b>	Arabic / Bulgarian / Czech / Danish / Dutch / English / French / German / Greek / Hebrew / Hungarian / Indonesian / Italian / Japanese / Lithuanian / Norwegian / Persian / Polish / Portuguese / Romanian / Russian / Serbian / Simplified Chinese / Slovakian / Slovenian / Spanish / Swedish / Thai / Traditional Chinese / Turkish	

## Specifications

Application	
<b>Network Storage</b>	GV-System (GV-DVR/NVR), GV-VMS, GV-Recording Server
<b>Smart Device Access</b>	<ul style="list-style-type: none"><li>- GV-Eye for Android and iOS</li><li>- Embedded 3GPP/ISMA browser</li></ul>
<b>Live Viewing</b>	IE, Chrome, Firefox, Edge, Safari, GV-Edge Recording Manager
<b>CMS Server support</b>	GV-Control Center, GV-Center V2, GV-Vital Sign Monitor
<b>LPR Management</b>	GV-ASManager
<b>Note:</b> All specifications are subject to change without notice.	

## GV-LPC2210

Camera		
Image Sensor	1/2.8" progressive scan super low lux CMOS	
Picture Elements	1920 (H) x 1080 (V)	
Camera Type	Color, B/W	
Shutter Speed	Automatic, Manual (1/120 ~ 1/2000 sec)	
White Balance	Auto / Manual (2800K ~ 8500K)	
S/N Ratio	52 dB	
Max. Speed	120 km/h (75 mph)	
Lens		
Megapixel	2 MP	
Lens Type	Motorized varifocal lens	
Focal Length	9 ~ 22 mm	
Maximum Aperture	F/1.2	
Mount	Ø14 mm	
Image Format	1/2.7"	
Horizontal FOV	38° ~ 18°	
Operation	Focus	Auto Focus
	Zoom	2.5x Optical Zoom
	Iris	P-Iris
IR LED Quantity	4 high power IR LEDs	
IR Distance	10 ~ 20 m (32.8 ~ 65.6 ft)	
Operation		
Video Compression	H.264, MJPEG	
Video Stream	Dual streams from H.264 and MJPEG	
Frame Rate	30 fps at 1920 x 1080 *The frame rate and the performance may vary depending on the number of connections and data bitrates (different scenes)	
Image Setting	Brightness, Contrast, Saturation, Sharpness, Gamma, Auto Exposure, White Balance, Flicker less, Image Orientation, Shutter Speed, Maximum Video Gain, D/N Sensitivity, Denoise, Defog, Metering	

## Specifications

<b>Audio Compression</b>		G.711, AAC (Optional)
<b>Audio Support</b>		Two-way audio
<b>Video Resolution</b>		
<b>Main Stream</b>	<b>4:3</b>	1600 x 1200, 1280 x 960, 640 x 480, 320 x 240
	<b>16:9</b>	1920 x 1080, 1280 x 720, 640 x 360, 448 x 252
	<b>5:4</b>	1280 x 1024, 640 x 512, 320 x 256
<b>Sub Stream</b>	<b>4:3</b>	640 x 480, 320 x 240
	<b>16:9</b>	640 x 360, 448 x 252
	<b>5:4</b>	640 x 512, 320 x 256
<b>TV-Out</b>		NTSC, PAL (640 x 480 resolution)
<b>Network</b>		
<b>Interface</b>		10/100 Base-T Ethernet, RJ-45 connector
<b>Protocol</b>		HTTP, HTTPS, TCP, UDP, SMTP, FTP, DHCP, NTP, UPnP, DynDNS, 3GPP/ISMA, RTSP, PSIA, SNMP, QoS (DSCP), ONVIF (Profile S)
<b>Mechanical</b>		
<b>Temperature Detector</b>		Yes
<b>Camera Angle Adjustment</b>	<b>Pan</b>	0° ~ 270°
	<b>Tilt</b>	0° ~ 70°
<b>Connectors</b>	<b>Power</b>	DC 48V, AC 24V (optional), High PoE (PoE++, 120 W)
	<b>Ethernet</b>	RJ-45
	<b>Audio</b>	1 In (Stereo phone jack, 3.5 mm / 0.14")
		1 Out (Stereo phone jack, 3.5 mm / 0.14")
	<b>Digital I/O</b>	1 In / 1 Out
<b>TV-Out</b>	BNC connector (640 x 480 resolution)	
<b>LED Indicator</b>		N/A

General		
Operating Temperature	-40°C ~ 50°C (-40°F ~ 122°F)	
Humidity	10% ~ 90% (non-condensation)	
Power Source	DC 48V 2.5A, AC 24V 3A (optional), High PoE (PoE++, 120 W) *If you require AC 24V 3A for optional operation, please specify upon ordering for the correct value of capacitance to be placed in the camera.	
Max. Power Consumption	50 W	
Dimensions	Without support rack	406 x 145 x 109 mm (16" x 5.7" x 4.3")
	Cable Length	1 m (3.28 ft)
Weight	With support rack	3.32 kg (7.32 lb)
	Without support rack	2.62 kg (5.78 lb)
Ingress Protection	IP67	
Vandal Resistance	IK10 for metal casing	
Heater On	-40°C ~ 8°C (-40°F ~ 46.4°F)	
Fan	Constantly On	
Regulatory	CE, FCC, RCM, RoHS compliant	
Power over Ethernet		
PoE Standard	High Power Over Ethernet (PoE ++)/ PD	
PoE Power Supply Type	Mid-Span	
PoE Power Output	DC 48V, 2.5A (120 W Max.)	
<b>Note:</b> Optionally purchasing GV-PA482 PoE Adapter is required for applying PoE function.		
Web Interface		
Installation & Management	Web-based configuration	
Firmware Upgrade	Remote upgrade through Web Browser GV-IP Device Utility included in the Software DVD	
Access from Web Browser	Live View, Video Recording, Video Quality, Bandwidth Control, Image Snapshot, Audio, Picture in Picture, Picture and Picture, Privacy Mask, Tampering Alarm, Text Overlay	

## Specifications

<b>Language</b>	Arabic / Bulgarian / Czech / Danish / Dutch / English / Finnish / French / German / Greek / Hebrew / Hungarian / Indonesian / Italian / Japanese / Lithuanian / Norwegian / Persian / Polish / Portuguese / Romanian / Russian / Serbian / Simplified Chinese / Slovakian / Slovenian / Spanish / Swedish / Thai / Traditional Chinese / Turkish
<b>Application</b>	
<b>Network Storage</b>	GV-System (GV-DVR/NVR), GV-VMS, GV-Recording Server
<b>Smart Device Access</b>	<ul style="list-style-type: none"> <li>- GV-Eye for Android and iOS</li> <li>- Embedded 3GPP/ISMA browser</li> </ul>
<b>Live Viewing</b>	IE, Chrome, Firefox, Edge, Safari
<b>CMS Server support</b>	GV-Control Center, GV-Center V2, GV-Vital Sign Monitor
<b>LPR Management</b>	GV-ASManager
<b>Note:</b> All specifications are subject to change without notice.	

## GV-LPC2211 / 2011

Camera		LPC2211	LPC2011
Image Sensor		1/2.8" progressive scan super low lux CMOS	
Picture Elements		1920 (H) x 1080 (V)	
Camera Type		Color, B/W	
Minimum Illumination	Color	0.05 Lux	
	B/W	0.04 Lux	
	IR ON	0 Lux	
Shutter Speed		Automatic, Manual(1/120 ~ 1/2000 sec)	
White Balance		Auto / Manual (2800K ~ 8500K)	
S/N Ratio		56 dB	
Max. Speed		120 km/h (75 mph)	60 km/h (37 mph)
Lens		LPC2211	LPC2011
Megapixel		2 MP	
Lens Type		Motorized varifocal lens	
Focal Length		9 ~ 22 mm	3 ~ 9 mm
Maximum Aperture		F/2.0 ~ F/3.5	F/1.7
Mount		Ø14 mm	
Image Format		1/2.7"	
Horizontal FOV		39° ~ 17°	102° ~ 40°
Operation	Focus	Remote Focus	
	Zoom	2.5x Optical Zoom	3x Optical Zoom
	Iris	P-Iris	
IR LED Quantity		24 IR LEDs	
IR Distance		10 ~ 20 m (32.8 ~ 65.6 ft)	5 ~ 9 m (16.4 ~ 29.6 ft)
Operation		LPC2211	LPC2011
Video Compression		H.264, MJPEG	
Video Stream		Dual streams from H.264 and MJPEG	
Frame Rate		30 fps at 1920 x 1080 *The frame rate and the performance may vary depending on the number of connections and data bitrates (different scenes)	



## Specifications

<b>Image Setting</b>		Brightness, Contrast, Saturation, Sharpness, Gamma, Auto Exposure, White Balance, Flicker less, Image Orientation, Shutter Speed, Maximum Video Gain, D/N Sensitivity, Denoise, Defog, Metering
<b>Audio Compression</b>		N/A
<b>Audio Support</b>		N/A
<b>Video Resolution</b>		<b>LPC2211</b> <b>LPC2011</b>
<b>Main Stream</b>	<b>16.9</b>	1920 x 1080, 1280 x 720
<b>Sub Stream</b>	<b>16.9</b>	640 x 360
<b>Network</b>		<b>LPC2211</b> <b>LPC2011</b>
<b>Interface</b>		10/100 Base-T Ethernet, RJ-45 connector
<b>Protocol</b>		HTTP, HTTPS, TCP, UDP, SMTP, FTP, DHCP, NTP, UPnP, DynDNS, 3GPP/ISMA, RTSP, PSIA, SNMP, QoS (DSCP), ONVIF (Profile S)
<b>Mechanical</b>		<b>LPC2211</b> <b>LPC2011</b>
<b>Temperature Detector</b>		Yes
<b>Camera Angle Adjustment</b>	<b>Pan</b>	0° ~ 360°
	<b>Tilt</b>	90° ~ 180°
<b>Connectors</b>	<b>Power</b>	2-pin terminal block, PoE
	<b>Ethernet</b>	RJ-45
	<b>Audio</b>	N/A
	<b>Digital I/O</b>	N/A
	<b>TV-Out</b>	N/A
<b>LED Indicator</b>		N/A
<b>General</b>		<b>LPC2211</b> <b>LPC2011</b>
<b>Operating Temperature</b>	Start-up	-20°C ~ 50°C (-4°F ~ 122°F)
	Operation	-30°C ~ 50°C (-22°F ~ 122°F)
<b>Humidity</b>		10% ~ 90% (non-condensation)
<b>Power Source</b>		DC 12V, PoE (IEEE 802.3af)
<b>Max. Power Consumption</b>		12.3 W
<b>Dimensions</b>		142.14x 77.72 x 102.75 mm (5.6" x 3.06" x 4.05")
<b>Weight</b>		810 g (1.8 lb)
<b>Ingress Protection</b>		IP67
<b>Vandal Resistance</b>		IK10 for metal casing
<b>Regulatory</b>		CE, FCC, RCM, RoHS compliant

<b>Power over Ethernet</b>	<b>LPC2211</b>	<b>LPC2011</b>
<b>PoE Standard</b>	IEEE (802.3af Power over Ethernet / PD)	
<b>PoE Power Supply Type</b>	End-Span	
<b>PoE Power Output</b>	Per Port 48V DC, 350 mA, Max. 15.4 watts	
<b>Web Interface</b>	<b>LPC2211</b>	<b>LPC2011</b>
<b>Installation &amp; Management</b>	Web-based configuration	
<b>Firmware Upgrade</b>	Remote upgrade through Web Browser GV-IP Device Utility included in the Software DVD	
<b>Access from Web Browser</b>	Camera Live View, Video Recording, Video Quality, Bandwidth Control, Image Snapshot, Picture in Picture, Picture and Picture, Privacy Mask, Tampering Alarm, Text Overlay, Motion Detection, IP Address Filtering, Digital PTZ	
<b>Language</b>	Arabic / Bulgarian / Czech / Danish / Dutch / English / French / German / Greek / Hebrew / Hungarian / Indonesian / Italian / Japanese / Lithuanian / Norwegian / Persian / Polish / Portuguese / Romanian / Russian / Serbian / Simplified Chinese / Slovakian / Slovenian / Spanish / Swedish / Thai / Traditional Chinese / Turkish	
<b>Application</b>	<b>LPC2211</b>	<b>LPC2011</b>
<b>Network Storage</b>	GV-System(GV-DVR/NVR),GV-VMS,GV-Recording Server	
<b>Smart Device Access</b>	<ul style="list-style-type: none"> <li>- GV-Eye for Android and iOS</li> <li>- Embedded 3GPP/ISMA browser</li> </ul>	
<b>Live Viewing</b>	IE, Chrome, Firefox, Edge, Safari	
<b>CMS Server support</b>	GV-Control Center, GV-Center V2, GV-Vital Sign Monitor	
<b>LPR Management</b>	GV-ASManager	
<b>Note:</b>		
<ol style="list-style-type: none"> <li>1. Try to avoid placing the camera where it can be subjected to direct LED light. The LED lighting from vehicles, streetlights, etc. may cause flickering images.</li> <li>2. All specifications are subject to change without notice.</li> </ol>		

## Appendix

### A. The CGI Command

You can obtain a snapshot of the live view or access the User Account Web interface simply by executing CGI commands. Follow the details below:

IP address: 192.168.2.11

Username: admin

Password: admin

Desired Stream: 1

- To obtain a snapshot of live view, type the following into your Web browser:

<http://192.168.2.11/PictureCatch.cgi?username=admin&password=admin&channel=1>

- To access the User Account settings on the Web interface, type the following into your Web browser:

<http://192.168.2.11/ConfigPage.cgi?username=admin&password=admin&page=UserSetting>

## B. RTSP Protocol Support

The cameras support RTSP protocol for both video and audio streaming. For RTSP command, enter:

```
rtsp://<IP of the GV-IP LPR Camera:8554/<CH No.>.sdp
```

For example, `rtsp://192.168.3.111:8554/CH001.sdp`

---

**Note:**

1. The RTSP server must be enabled on the Web interface. See Figure 4-20.
  2. Only VLC and QuickTime players are supported for streaming video via RTSP protocol.
-

## C. Settings for Internet Explorer 8 or later

If you use Internet Explorer 8 or later, it is required to complete the following setting.

1. Set the Security to **Medium-high (default)**.
2. Enable **Allow previously unused ActiveX controls to run without prompt**.
3. Disable **Only allow approved domains to use ActiveX without prompt**.

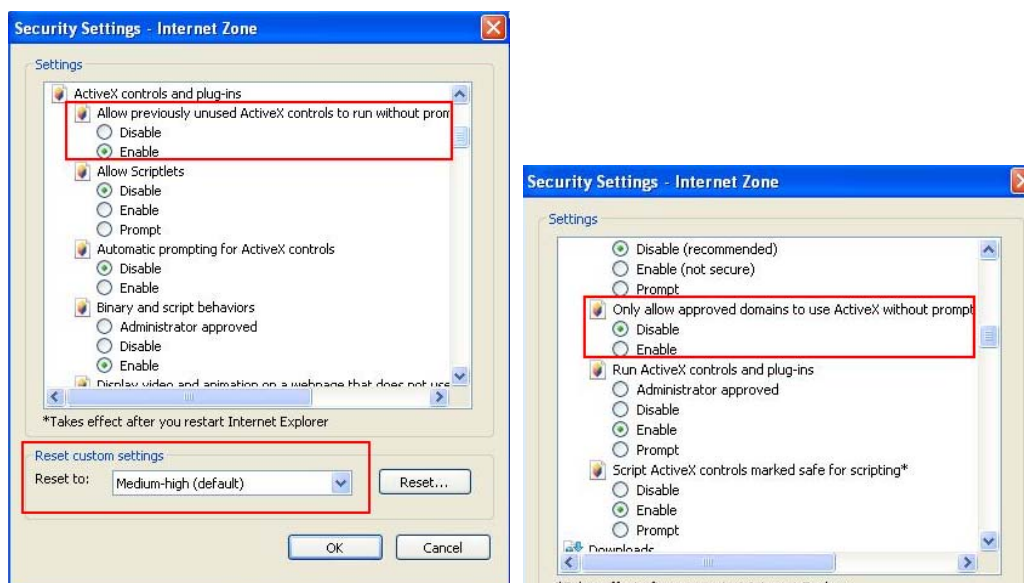

## D. Supported UMTS Protocol (3G Modem)

Brand	Model
Huawei	E220, E392
	E169, E1692, E156, EC189, E1752, E1756, E1756C, E169C
Novatel	MC998D
	USB760, USB727, MC950D
ONDA	MSA523HS
ZTE	MF100